

# TEST REPORT

Product Name : DataHub  
Model Number : DataHub1000

Prepared for : SolaX Power Network Technology (Zhejiang) Co., Ltd.  
Address : No.288,Shizhu Road, Tonglu Economic Development Zone,  
Tonglu City, Zhejiang Province 310000,P. R. CHINA

Prepared by : EMTEK (SHENZHEN) CO., LTD.  
Address : Building 69, Majialong Industry Zone, Nanshan District,  
Shenzhen, Guangdong, China

Tel: (0755) 26954280  
Fax: (0755) 26954282

Report Number : ENS2111250113W01901R  
Date(s) of Tests : November 25, 2021 to January 22, 2022  
Date of issue : January 23, 2022



## TABLE OF CONTENTS

Description	Page
<b>1. TEST REPORT DESCRIPTION .....</b>	<b>4</b>
<b>2. GENERAL INFORMATION .....</b>	<b>6</b>
<b>3. DESCRIPTION OF STANDARDS AND RESULTS (EUT) .....</b>	<b>7</b>
<b>4. TEST METHODOLOGY .....</b>	<b>8</b>
4.1. GENERAL DESCRIPTION OF APPLIED STANDARDS .....	8
4.2. MEASURING DEVICE AND TEST EQUIPMENT .....	8
4.3. DESCRIPTION OF TEST MODES .....	12
4.4. Test Software.....	12
4.5. BLOCK DIAGRAM CONFIGURATION OF TEST SYSTEM .....	13
4.6. SUPPORT EQUIPMENT .....	13
<b>5. FACILITIES AND ACCREDITATIONS .....</b>	<b>14</b>
5.1. FACILITIES.....	14
5.2. LABORATORY ACCREDITATIONS AND LISTINGS .....	14
5.3. Measurement Uncertainty .....	15
<b>6. CONDUCTED EMISSIONS FROM THE AC MAINS POWER PORTS .....</b>	<b>16</b>
6.1. Block Diagram of Test Setup .....	16
6.2. Measuring Standard .....	16
6.3. Limits .....	16
6.4. Test Procedure .....	16
6.5. Measuring Results .....	17
<b>7. CONDUCTED EMISSIONS FROM THE DC MAINS POWER PORTS .....</b>	<b>20</b>
7.1. Block Diagram of Test Setup .....	20
7.2. Measuring Standard .....	20
7.3. Conducted Emission Limits .....	20
7.4. Test Procedure .....	20
7.5. Measuring Results .....	21
<b>8. ASYMMETRIC MODE CONDUCTED EMISSIONS AT WIRED NETWORK PORTS.....</b>	<b>22</b>
8.1. Block Diagram of Test Setup.....	22
8.2. Measuring Standard .....	22
8.3. Limits .....	22
8.4. Test Procedure .....	23
8.5. Measuring Results .....	23
<b>9. RADIATED EMISSION .....</b>	<b>25</b>
9.1. Block Diagram of Test Setup .....	25
9.2. Measuring Standard .....	25
9.3. Radiated Limit.....	26
9.4. Test Procedure .....	26
9.5. Measuring Results .....	27
<b>10. HARMONIC CURRENT EMISSION MEASUREMENT.....</b>	<b>32</b>
10.1. Block Diagram of Test Setup .....	32
10.2. Measuring Standard .....	32
10.3. Standard Limits .....	32
10.4. Test Procedure .....	33
10.5. Test Results .....	33
<b>11. VOLTAGE FLUCTUATION AND FLICKER MEASUREMENT .....</b>	<b>37</b>
11.1. Block Diagram of Test Setup .....	37
11.2. Measuring Standard .....	37
11.3. Standard Limits .....	37
11.4. Test Procedure .....	37

11.5.Test Results .....	37
<b>12. PERFORMANCE CRITERIA .....</b>	<b>39</b>
12.1.General performance criteria .....	39
12.2.Performance table .....	39
<b>13. ELECTROSTATIC DISCHARGE .....</b>	<b>40</b>
13.1.Test Specification .....	40
13.2.Block Diagram of Test Setup .....	40
13.3.Test Procedure .....	40
13.4.Test Results .....	41
<b>14. CONTINUOUS RF ELECTROMAGNETIC FIELD DISTURBANCES.....</b>	<b>43</b>
14.1.Test Specification .....	43
14.2.Block Diagram of Test Setup .....	43
14.3.Test procedure.....	43
14.4.Test results .....	44
<b>15. ELECTRICAL FAST TRANSIENTS/BURST.....</b>	<b>45</b>
15.1.Test Specification .....	45
15.2.Block Diagram of Test Setup .....	45
15.3.Test Procedure .....	46
15.4.Test Results .....	46
<b>16. SURGES .....</b>	<b>47</b>
16.1.Test Specification .....	47
16.2.Block Diagram of Test Setup .....	47
16.3.Test Procedure .....	47
16.4.Test results .....	48
<b>17. CONTINUOUS INDUCED RF DISTURBANCES .....</b>	<b>49</b>
17.1.Test Specification .....	49
17.2.Block Diagram of Test Setup .....	49
17.3.Test Procedure .....	49
17.4.Test results .....	50
<b>18. RANSIENTS AND SURGES IN THE VEHICULAR ENVIRONMENT.....</b>	<b>51</b>
18.1.Test Specification .....	51
18.2.Block Diagram of Test Setup .....	51
18.3.Test Procedure .....	51
18.4.Test Results .....	52
<b>19. VOLTAGE DIPS AND INTERRUPTIONS .....</b>	<b>53</b>
19.1.Test Specification .....	53
19.2.Block Diagram of Test Setup .....	53
19.3.Test Procedure .....	53
19.4.Test results .....	54
<b>20. PHOTOGRAPHS .....</b>	<b>55</b>
20.1.Photos of Conducted Emissions from the AC Mains Power Ports .....	55
20.2.Photos of Radiation Emission Measurement.....	56
20.3.Photo of Harmonic / Flicker Measurement .....	56
20.4.Photo of Continuous RF Electromagnetic Field Disturbances .....	57
20.5.Photos of Electrical Fast Transients/Burst.....	58
20.6.Photo of Voltage Dips and Interruptions.....	61
<b>21. PHOTOS OF EUT .....</b>	<b>62</b>

# 1. TEST REPORT DESCRIPTION

Applicant : SolaX Power Network Technology (Zhejiang) Co., Ltd.  
 Address : No.288,Shizhu Road, Tonglu Economic Development Zone, Tonglu City, Zhejiang Province 310000,P. R. CHINA  
 Manufacturer : SolaX Power Network Technology (Zhejiang) Co., Ltd.  
 Address : No.288,Shizhu Road, Tonglu Economic Development Zone, Tonglu City, Zhejiang Province 310000,P. R. CHINA  
 Trade Mark : SolaX Power  
 EUT : DataHub  
 Model No. : DataHub1000

### Measurement Procedure Used:

APPLICABLE STANDARDS	
STANDARD	TEST RESULT
ETSI EN 301 489-1 v2.2.3: 2019	PASS
ETSI EN 301 489-17 v3.2.4: 2020	PASS

The device described above is tested by EMTEK (SHENZHEN) CO., LTD. to determine the maximum emission levels emanating from the device and the severe levels of the device can endure and its performance criterion. The measurement results are contained in this test report and EMTEK (SHENZHEN) CO., LTD. is assumed full of responsibility for the accuracy and completeness of these measurements. Also, this report shows that the EUT (Equipment Under Test) is technically compliant with the ETSI EN 301 489-1 and ETSI EN 301 489-17 requirements.

This report applies to above tested sample only and shall not be reproduced in part without written approval of EMTEK (SHENZHEN) CO., LTD.

Date of Test : November 25, 2021 to January 22, 2022

Prepared by : Tracy Hu  
 Tracy Hu /Editor

Reviewer : Mill Chen  
 Mill Chen /Supervisor

Approved & Authorized Signer : Lisa Wang  
 Lisa Wang/Manager



## Modified History

Version	Report No.	Revision Date	Summary
\	ENS2111250113W01901R	\	Original Report



## 2. GENERAL INFORMATION

Product:	DataHub
Model Number:	DataHub1000
Sample Number:	1#
WLAN Supported:	<input checked="" type="checkbox"/> 802.11b <input checked="" type="checkbox"/> 802.11g <input checked="" type="checkbox"/> 802.11n(20MHz channel bandwidth) <input type="checkbox"/> 802.11n(40MHz channel bandwidth)
Modulation:	<input checked="" type="checkbox"/> DSSS with DBPSK/DQPSK/CCK for 802.11b <input checked="" type="checkbox"/> OFDM with BPSK/QPSK/16QAM/64QAM for 802.11g/n
Frequency Range:	<input checked="" type="checkbox"/> 2412-2472MHz for 802.11b/g/n(HT20) <input type="checkbox"/> 2422-2462MHz for 802.11n(HT40)
Number of Channels:	<input checked="" type="checkbox"/> 13 Channels for 802.11b/g/n(HT20) <input type="checkbox"/> 9 Channels for 802.11n(HT40)
Max Transmit Power:	18.68 dBm
Antenna:	External antenna
Antenna Gain:	5.0 dBi,
Test Voltage:	AC230V, 50Hz
AC Adapter:	M/N: ABT020120D Input: AC 100-240V, 50/60Hz, 1.5A Output: DC 12V, 2A, 24W
Date of Received:	November 25, 2021
Temperature Range:	-20°C~+60°C

**Note:** for more details, please refer to the user's manual of the EUT.

### 3. DESCRIPTION OF STANDARDS AND RESULTS (EUT)

Applicable Standard: ETSI EN 301 489-1 v2.2.3: 2019				
EMISSION				
Description of Test Item		Standard	Limits	Results
Conducted Emissions From the AC Mains Power Ports		EN 55032:2015	Class B	Pass
Conducted Emissions From the DC Mains Power Ports		EN 55032:2015	Class B	N/A
Asymmetric mode conducted emissions Wired network ports		EN 55032:2015	Class B	Pass
Radiated emissions at frequencies up to 1 GHz		EN 55032:2015	Class B	Pass
Radiated emissions at frequencies above 1 GHz		EN 55032:2015	Class B	Pass
Harmonic Current Emissions		EN IEC 61000-3-2: 2019	Class A	Pass
Voltage Fluctuation and Flicker		EN 61000-3-3:2013/ A1:2019	Section 5	Pass
IMMUNITY				
Description of Test Item		Basic Standard	Performance Criteria	Results
Electrostatic Discharge	Enclosure ports	EN 61000-4-2:2009	B	Pass
Continuous RF electromagnetic field disturbances	Enclosure ports	EN 61000-4-3:2006+ A1:2008+A2:2010	A	Pass
Electrical fast transients/burst	AC mains power ports	EN 61000-4-4:2012	B	Pass
	Analogue/digital data ports		B	Pass
	DC network power ports		N/A	N/A
Surges	AC mains power ports	EN 61000-4-5:2014	B	Pass
	Analogue/digital data ports		B	Pass
Continuous induced RF disturbances	AC mains power ports	EN 61000-4-6:2014	A	Pass
	Analogue/digital data ports		A	Pass
	DC network power ports		N/A	N/A
Vehicular transients and surges	DC power input ports	ISO 7637-2:2004	A & B	N/A
Voltage dips and interruptions	AC mains power ports	EN 61000-4-11:2004	B & C	Pass
Note: N/A is an abbreviation for not applicable.				

## 4. TEST METHODOLOGY

### 4.1. GENERAL DESCRIPTION OF APPLIED STANDARDS

According to its specifications, the EUT must comply with the requirements of the following standards:

ETSI EN 301 489-1: ElectroMagnetic Compatibility (EMC) standard for radio equipment and services; Part 1: Common technical requirements; Harmonised Standard covering the essential requirements of article 3.1(b) of Directive 2014/53/EU and the essential requirements of article 6 of Directive 2014/30/EU

ETSI EN 301 489-17: ElectroMagnetic Compatibility (EMC) standard for radio equipment and services; Part 17: Specific conditions for Broadband Data Transmission Systems; Harmonised Standard covering the essential requirements of article 3.1(b) of Directive 2014/53/EU

### 4.2. MEASURING DEVICE AND TEST EQUIPMENT

For Conducted Emission Measurement for AC

Equ.No.	Equipment	Manufacturer	Model No.	Serial No.	Last Cal.	Cal. Interval
EE-144	EMI Test Receiver	Rohde & Schwarz	ESCI	101045	2021/5/15	1Year
EE-023-2	PULSE LIMTER	Rohde & Schwarz	ESH3-Z2	100107	2021/5/15	1Year
EE-032	AMN	Rohde & Schwarz	ESH3-Z5	100191	2021/5/15	1Year
EE-156	AMN	Schwarzbeck	NNLK 8129	8129203	2021/5/15	1Year
EE-033	V-Network	Rohde & Schwarz	ESH3-Z6	100011	2021/5/15	1Year
EE-138	V-Network	Rohde & Schwarz	ESH3-Z6	100253	2021/5/16	1Year

For 3m Radiated Emission Measurement

Equ.No.	Equipment	Manufacturer	Model No.	Serial No.	Last Cal.	Cal. Interval
EE-040	Pre-Amplifier	HP	8447F	2944A07999	2021/5/15	1Year
EE-343	EMI Test Receiver	Rohde & Schwarz	ESCI	101414	2021/5/15	1Year
EE-371	Bilog Antenna	Schwarzbeck	VULB9163	712	2021/7/5	2 Year
EE-247	Horn antenna	Schwarzbeck	BBHA9120D	9120D-1178	2020/7/4	2 Year
EE-237	Pre-Amplifie	Lunar EM	LNA1G18-48	J10111310100 01	2021/5/15	1Year
EE-230	Spectrum Analyzer	Rohde & Schwarz	FSV40	100967	2021/5/15	1Year
EE-095	Horn antenna	Schwarzbeck	BBHA9170	9170-399	2021/6/12	2 Year
EE-157	Loop Antenna	Schwarzbeck	FMZB1519	1519-012	2021/6/12	2 Year



## For Harmonic Current / Flicker Measurement

Equ.No.	Equipment	Manufacturer	Model No.	Serial No.	Last Cal.	Cal. Interval
EE-357-1	Power Source	AB SCIEX	5001IX-CTS-400-413	N/A	2021/5/15	1 Year
EE-357	Harmoniv Flicker test system	AB SCIEX	PACS-1	1413A02055	2021/5/15	1 Year

## For Electrostatic Discharge Immunity Test

Equ.No.	Equipment	Manufacturer	Model No.	Serial No.	Last Cal.	Cal. Interval
EE-195	ESD Tester	TESEQ	NSG 438A	130	2021/7/7	1 Year

## For Radio-frequency, Electromagnetic Field Immunity

Equ.No.	Equipment	Manufacturer	Model No.	Serial No.	Last Cal.	Cal. Interval
EE-066-2	Power Amplifier	MILMEGA	AS0102-55	1018770	May 16, 2021	1 Year
EE-066-4	50ohm Diode Power Sensor	BOONTON	51011EMC	34236	May 16, 2021	1 Year
EE-066-6	RF Power Meter. Dual Channel	BOONTON	4232A	10539	May 16, 2021	1 Year
EE-067	Log.-Per. Antenna	SCHWARZBEC K	VULP 9118E	811	N/A	N/A
EE-218	Signal Generator	Agilent	N5181A	MY50145187	May 16, 2021	1 Year
EE-219	50ohm Diode Power Sensor	BOONTON	51011EMC	36164	May 16, 2021	1 Year
EE-220	Broad-Band Horn Antenna	SCHWARZBEC K	STLP 9149	9149-227	N/A	N/A
EE-221	Field Strength Meter	DARE	RSS1006A	10I00037SNO2 2	May 16, 2021	1 Year
EE-222	Multi-function interface system	DARE	CTR1009B	12I00250SNO7 2	N/A	N/A
EE-223	Automatic switch group	DARE	RSW1004A	N/A	N/A	N/A
EE-224	Power Amplifier	MILMEGA	AS1860-50	1059346	May 16, 2021	1 Year
EE-225	Power Amplifier	MILMEGA	80RF1000-175	1059345	May 16, 2021	1 Year
EE-225-1	Directional Coupler	MILMEGA	DC6180AM1	0340463	May 16, 2021	1 Year
EE-115	Audio Analyzer	R&S	UPV	101473	May 16, 2021	1 Year

EE-615	Audio Test System	AUDIO PRECISION	ATS-1	41100	June 29, 2021	1 Year
EE-600	Wideband Radio Communication Tester	R&S	CMW500	147366	May 16, 2021	1 Year

## For Electrical Fast Transient / Burst Immunity Test

Equ.No.	Equipment	Manufacturer	Model No.	Serial No.	Last Cal.	Cal. Interval
EE-014	Burst Tester	HAEFELY	PEFT4010	080981-16	2021/5/16	1Year
EE-015	Coupling Clamp	HAEFELY	IP-4A	147147	2021/5/16	1Year
EE-205	Three phase CDN	Teseq	CDN 163	202	2021/5/15	1 Year

## For Surge Immunity Test

Equ.No.	Equipment	Manufacturer	Model No.	Serial No.	Last Cal.	Cal. Interval
EE-162	Controller	HAEFELY	Psurge 8000	174031	2020/5/16	1Year
EE-162-1	Impulse Module	HAEFELY	PIM 100	174124	2021/5/16	1Year
EE-162-2	Coupling Decoupling	HAEFELY	PCD 130	172181	2021/5/17	1Year
EE-162-3	Coupling Module	HAEFELY	PCD122	174354	2021/5/16	1Year
EE-162-4	Impulse Module	HAEFELY	PIM 120	174435	2021/5/16	1Year
EE-162-5	Coupling Module	HAEFELY	PCD 126A	174387	2021/5/16	1Year
EE-162-6	Impulse Module	HAEFELY	PIM 110	174391	2021/5/16	1Year
EE-227	Impulse Module	HAEFELY	PIM 150	178707	2021/5/16	1Year
EE-623	Impulse Module	PMI	PCDN8	190422	2021/5/15	1Year

## For Immunity Test of Conducted Disturbance Induced by RF Field

Equ.No.	Equipment	Manufacturer	Model No.	Serial No.	Last Cal.	Cal. Interval
EE-007-1	Continuous Wave Simulator	EMTEST	CWS500C	0900-12	2021/5/15	1Year
EE-007-2	CDN	EMTEST	CDN-M2	510010010010	2021/5/15	1Year
EE-007-3	CDN	EMTEST	CDN-M3	0900-11	2021/5/15	1Year
EE-007-4	EM Injection Clamp	EMTEST	F-2031-23MM	368	2021/5/15	1Year
EE-007-5	Attenuator	EMTEST	100W 6dB DC-3G	/	2021/5/15	1Year
EE-111	Signal Generator	R&S	SMB100A	103041	2021/5/15	1Year

EE-146	CDN	LUTHI	CDN L-801 M2/M3	2606	2021/5/15	1Year
EE-204	Three phase CDN	TESEQ	CDN M332S	32655	2021/5/15	1 Year
EE-204-1	Three phase CDN	TESEQ	CDN M432S	33670	2021/5/15	1 Year
EE-204-2	Three phase CDN	TESEQ	CDN M432-3LNS	34048	2021/5/15	1 Year
EE-204-3	Three phase CDN	TESEQ	CDN M532S	33799	2021/5/15	1 Year
EE-345	Current Injection Clamp	FCC	F-120-9	140302	2021/5/15	1 Year
EE-616	Power meter	AGILENT	E4418B	MY45102886	2021/5/15	1 Year
EE-616-1	Directional coupler	SKET	DC_0110000M-100 W	SK2018080301	2021/5/15	1 Year
EE-615	Audio Test System	AUDIO PRECISION	ATS-1	41100	2021/5/15	1 Year

## For Voltage Dips and Interruptions Test

Equ.No.	Equipment	Manufacturer	Model No.	Serial No.	Last Cal.	Cal. Interval
EE-206	45KVA AC Power source	Teseq	NSG 1007-45/45KVA	1305A02873	2021/5/15	1 Year
EE-206-1	Signal conditioning Unit	Teseq	CCN 1000-3	1305A02873	2021/6/10	1 Year
EE-206-2	Impedance network	Teseq	INA2197/37A	1305A02873	2021/6/10	1 Year
EE-206-3	Impedance network	Teseq	INA 2196/75A	1305A02874	2021/6/10	1 Year
EE-207	Proflin 2100 AC Switching Unit	Teseq	NSG 2200-3	A22714	2021/6/10	1 Year

### 4.3. DESCRIPTION OF TEST MODES

Investigation has been done on all the possible configurations for searching the worst cases. The following table is a list of the test modes shown in this test report.

Test Mode	Description
1	WIFI Control
2	Standby
/	/

### 4.4. Test Software

Item	Software
Conducted Emission:	EMTEK(Ver.CON-03A1)-Shenzhen
Radiated Emission:	EMTEK(Ver.RA-03A1)-Shenzhen

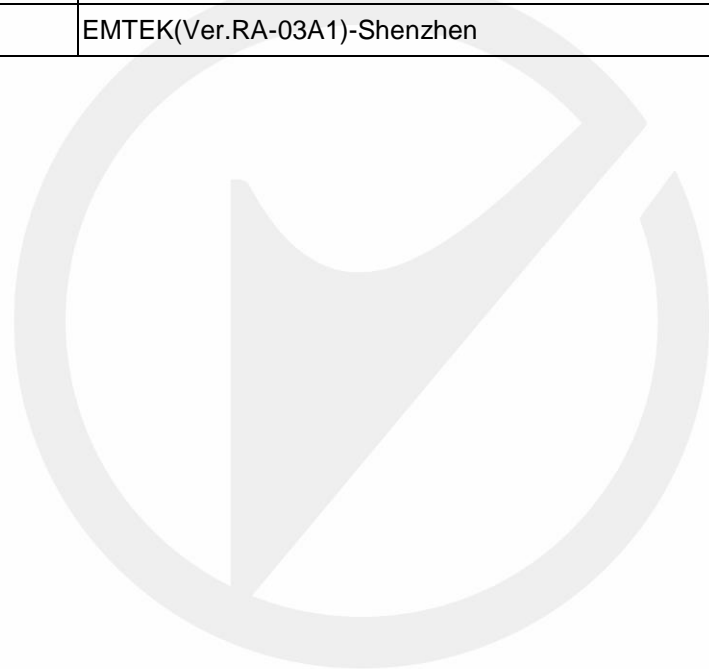

#### 4.5. BLOCK DIAGRAM CONFIGURATION OF TEST SYSTEM

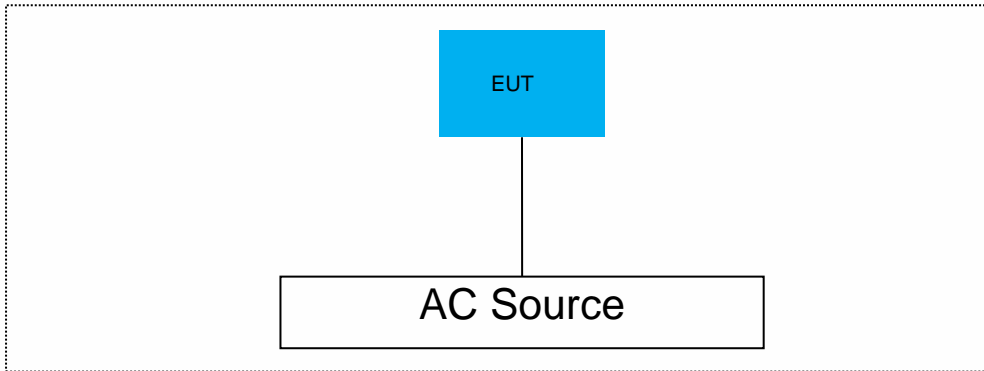

#### 4.6. SUPPORT EQUIPMENT

EUT Cable List and Details			
Cable Description	Length (m)	Shielded/Unshielded	With / Without Ferrite
/	/	/	/

Auxiliary Cable List and Details			
Cable Description	Length (m)	Shielded/Unshielded	With / Without Ferrite
/	/	/	/

Auxiliary Equipment List and Details			
Description	Manufacturer	Model	Serial Number
/	/	/	/

**Note:**

1. All the equipment/cables were placed in the worst-case configuration to maximize the emission during the test.
2. Grounding was established in accordance with the manufacturer's requirements and conditions for the intended use.

## 5. FACILITIES AND ACCREDITATIONS

### 5.1. FACILITIES

All measurement facilities used to collect the measurement data are located at:

EMTEK (SHENZHEN) CO., LTD.

Building 69, Majialong Industry Zone District, Nanshan District, Shenzhen, China

The sites are constructed in conformance with the requirements of ANSI C63.7, ANSI C63.4 and CISPR Publication 32.

### 5.2. LABORATORY ACCREDITATIONS AND LISTINGS

Site Description

EMC Lab.

: **Accredited by CNAS**

The Certificate Registration Number is L2291.

The Laboratory has been assessed and proved to be in compliance with CNAS-CL01 (identical to ISO/IEC 17025:2017)

**Accredited by FCC**

Designation Number: CN1204

Test Firm Registration Number: 882943

**Accredited by A2LA**

The Certificate Number is 4321.01.

**Accredited by Industry Canada**

The Conformity Assessment Body Identifier is CN0008

Name of Firm

: EMTEK (SHENZHEN) CO., LTD.

Site Location

: Bldg 69, Majialong Industry Zone, Nanshan District, Shenzhen, Guangdong, China

### 5.3. Measurement Uncertainty

Test Item	Uncertainty
Conducted Emission Uncertainty	: 2.08 dB(9k~150kHz Conduction 1#) 2.40 dB(150k-30MHz Conduction 1#)
Radiated Emission Uncertainty (3m Chamber)	: 4.30 dB (30M~1GHz Polarize: H) 4.90 dB (30M~1GHz Polarize: V) 3.70 dB (1GHz ~18GHz Polarize: H) 3.60 dB (1GHz ~18GHz Polarize: V)
Uncertainty for Flicker test	: 0.514% V
Uncertainty for Harmonic test	: 3.82% mA
Uncertainty for ESD Test	: 6 % kV
Uncertainty for EFT/B Test	: 3.84 % kV
Uncertainty for Surge Test	: 0.53 % kV
Uncertainty for C/S Test	: 0.96 dB(Using CDN Test)
Uncertainty for R/S Test	: 1.64 dB(80MHz-6000MHz)
Uncertainty for DIPS Test	: 2.12 % V
Uncertainty for test site temperature and humidity	: 0.6°C 4%

## 6. CONDUCTED EMISSIONS FROM THE AC MAINS POWER PORTS

### 6.1. Block Diagram of Test Setup

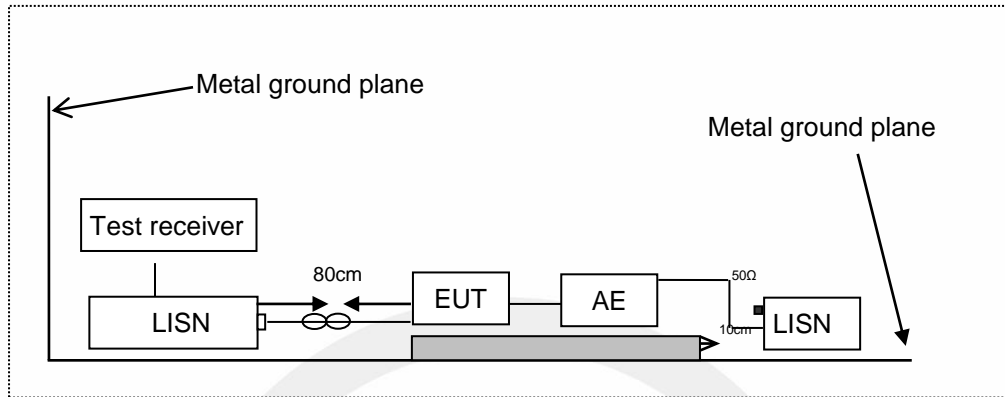

AMN: Artificial Mains Network  
AE: Associated equipment  
EUT: Equipment under test

### 6.2. Measuring Standard

ETSI EN 301 489-1 Clause 8.4  
EN 55032: 2015 Clause A.3

### 6.3. Limits

EN 55032, Class B, Table A.10

Frequency range MHz	Coupling device (see Table A.8)	Detector type / bandwidth	Class B limits dB( $\mu$ V)
0.15 to 0.5	AMN	Quasi Peak / 9 kHz	66 to 56
0.5 to 5			56
5 to 30			60
0.15 to 0.5	AMN	Average / 9 kHz	56 to 46
0.5 to 5			46
5 to 30			50

### 6.4. Test Procedure

The EUT was placed on a desk 0.8 m height from the metal ground plane and 0.4 m from the conducting wall of the shielding room and it was kept at least 0.8 m from any other grounded conducting surface. The size of the table will nominally be 1.5 m x1.0 m.

The rear of the arrangement shall be flush with the back of the supporting tabletop unless that would not be possible or typical of normal use.

All units of equipment forming the system under test (includes the EUT as well as connected peripherals and associated equipment or devices) shall be arranged such that a nominal 0.1 m



separation is achieved between the neighboring units.

Connect EUT to the power mains through a artificial mains network (AMN). Where the mains cable supplied by the manufacturer is longer than 1 m, the excess should be folded at the centre into a bundle no longer than 0.4 m, so that its length is shortened to 1 m.

All the support units are connecting to the other AMN.

The AMN provides 50 ohm coupling impedance for the measuring instrument.

The CISPR states that the AMN with 50 ohm and 50 microhenry should be used.

Both sides of AC line were checked for maximum conducted interference.

The bandwidth of the receiver is set at 9 kHz in 150 kHz~30 MHz. The frequency range from 150 kHz to 30 MHz is investigated.

Set the test-receiver system to quasi peak detect function and average detect function, and to measure the conducted emissions values.

Test results were obtained from the following equation:  
Measurement (dB $\mu$ V) =Correct Factor (dB) + Reading (dB $\mu$ V)  
Over (dB) = Measurement (dB $\mu$ V) - Limit (dB $\mu$ V)

## 6.5. Measuring Results

**PASS.**

All the modes were tested and the data of the worst modes are attached the following pages.

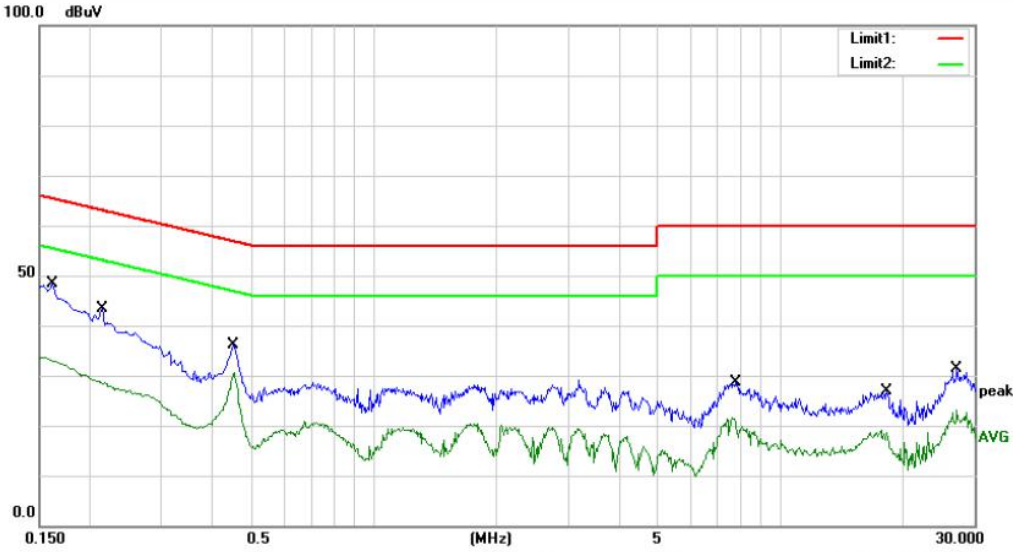

Site site #1 Phase: **L1** Temperature: 24  
 Limit: (CE)EN 55032 CLASS B\_QP Power: AC 230V/50Hz Humidity: 50 %  
 Mode: Wifi Control  
 Note:

No.	Mk.	Freq.	Reading Level	Correct Factor	Measurement	Limit	Over	Detector	Comment
		MHz	dBuV	dB	dBuV	dBuV	dB		
1		0.1620	38.10	10.10	48.20	65.36	-17.16	QP	
2		0.1620	22.80	10.10	32.90	55.36	-22.46	AVG	
3		0.2140	33.20	10.09	43.29	63.05	-19.76	QP	
4		0.2140	18.20	10.09	28.29	53.05	-24.76	AVG	
5		0.4500	25.90	10.07	35.97	56.88	-20.91	QP	
6	*	0.4500	20.30	10.07	30.37	46.88	-16.51	AVG	
7		7.7280	18.20	10.42	28.62	60.00	-31.38	QP	
8		7.7280	9.10	10.42	19.52	50.00	-30.48	AVG	
9		18.2440	16.20	10.59	26.79	60.00	-33.21	QP	
10		18.2440	7.90	10.59	18.49	50.00	-31.51	AVG	
11		27.1600	20.60	10.76	31.36	60.00	-28.64	QP	
12		27.1600	12.40	10.76	23.16	50.00	-26.84	AVG	

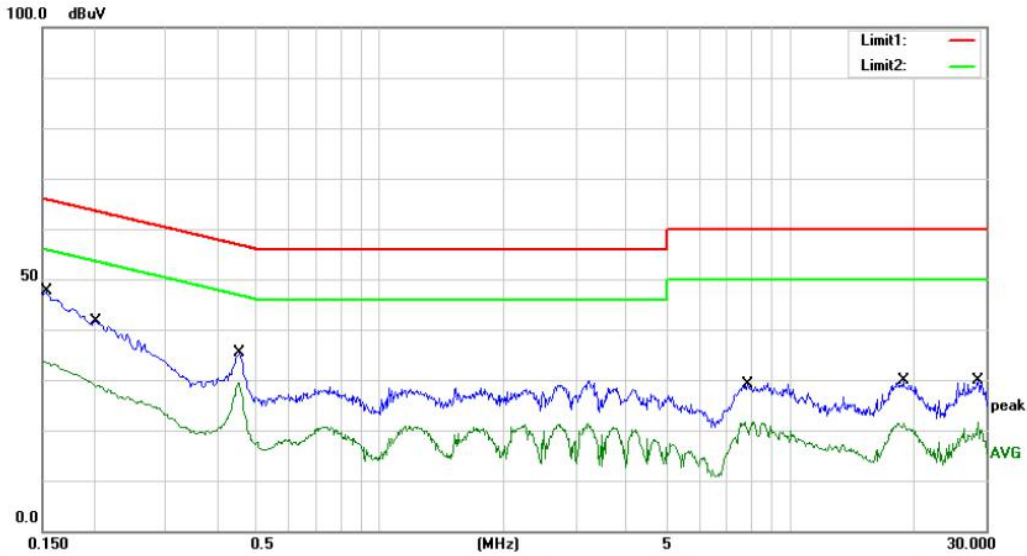

Site site #1 Phase: **N** Temperature: 24  
 Limit: (CE)EN 55032 CLASS B\_QP Power: AC 230V/50Hz Humidity: 50 %  
 Mode: Wifi Control  
 Note:

No.	Mk.	Freq.	Reading Level	Correct Factor	Measurement	Limit	Over	Detector	Comment
		MHz	dBuV	dB	dBuV	dBuV	dB		
1		0.1540	37.50	10.08	47.58	65.78	-18.20	QP	
2	*	0.1540	31.60	10.08	41.68	55.78	-14.10	AVG	
3		0.2020	31.60	10.08	41.68	63.53	-21.85	QP	
4		0.2020	18.00	10.08	28.08	53.53	-25.45	AVG	
5		0.4540	25.20	10.11	35.31	56.80	-21.49	QP	
6		0.4540	19.20	10.11	29.31	46.80	-17.49	AVG	
7		7.8700	18.60	10.45	29.05	60.00	-30.95	QP	
8		7.8700	9.60	10.45	20.05	50.00	-29.95	AVG	
9		18.9180	19.10	10.65	29.75	60.00	-30.25	QP	
10		18.9180	10.20	10.65	20.85	50.00	-29.15	AVG	
11		28.6860	19.00	10.41	29.41	60.00	-30.59	QP	
12		28.6860	11.10	10.41	21.51	50.00	-28.49	AVG	

## 7. CONDUCTED EMISSIONS FROM THE DC MAINS POWER PORTS

### 7.1. Block Diagram of Test Setup

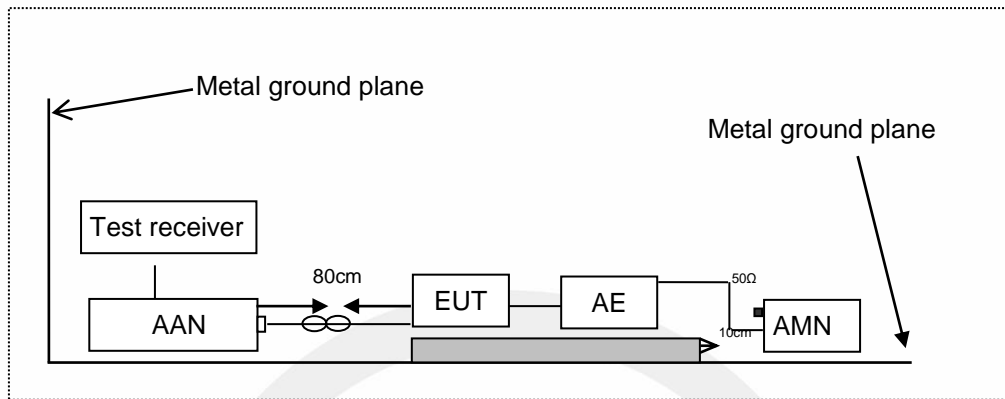

### 7.2. Measuring Standard

ETSI EN 301 489-1 Clause 8.3  
CISPR 25

### 7.3. Conducted Emission Limits

Power Line Conducted Emission Limits

Table clause	Frequency range MHz	Coupling device	Detector type / bandwidth	limits dB(μV)
A9.1	0,15 to 0,5	AMN	Quasi Peak / 9 kHz	79 to 73
	0,5 to 30			73
A9.2	0,15 to 0,5	AMN	Average / 9 kHz	66 to 60
	5 to 30			60
Apply A9.1 and A9.2 across the entire frequency range.				

### 7.4. Test Procedure

For mobile radio and ancillary equipment intended to be connected to the vehicle's onboard DC mains, an Artificial Network (AN) as specified in CISPR 25 [10] annex D shall be used and be connected to a DC power source.

The measurement frequency range extends from 150 kHz to 30 MHz. When the EUT is a transmitter operating at frequencies below 30 MHz, then the exclusion band for transmitters applies (see clause 4.3 of the present document) for measurements in the transmit mode of operation.

For emission measurements on DC output ports the relevant port shall be connected via an AMN/AN to a load drawing the rated current of the source.

The bandwidth of the receiver is set at 9 kHz in 150 kHz~30 MHz. The frequency range from 150 kHz to 30 MHz is investigated.

Test results were obtained from the following equation:  
Measurement (dB $\mu$ V) = Correct Factor (dB) + Reading (dB $\mu$ V)  
Over (dB) = Measurement (dB $\mu$ V) - Limit (dB $\mu$ V)

## 7.5. Measuring Results

**Not Applicable**



## 8. ASYMMETRIC MODE CONDUCTED EMISSIONS AT WIRED NETWORK PORTS

### 8.1. Block Diagram of Test Setup

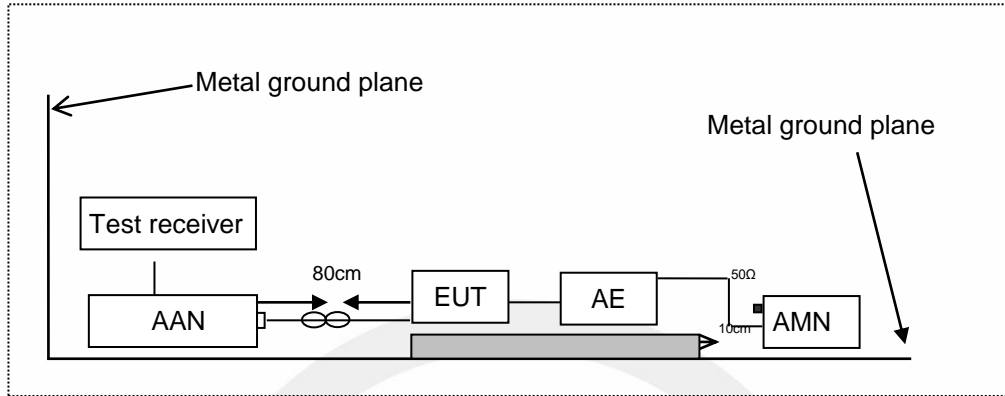

AMN: Artificial mains network  
 AE: Associated equipment  
 EUT: Equipment under test  
 AAN: Asymmetric artificial network

### 8.2. Measuring Standard

ETSI EN 301 489-1 Clause 8.7  
 EN 55032: 2015 Clause A.3

### 8.3. Limits

EN 55032, Class B, Table A.12

Frequency range (MHz)	Coupling device (see Table A.8)	Detector type / bandwidth	Class B voltage limits dB(μV)	Class B current limits dB(μA)
0.15 to 0.5	AAN	Quasi Peak / 9 kHz	84 to 74	N/A
0.5 to 30			74	
0.15 to 0.5	AAN	Average / 9 kHz	74 to 64	
0.5 to 30			64	
0.15 to 0.5	CVP and current probe	Quasi Peak / 9 kHz	84 to 74	40 to 30
0.5 to 30			74	30
0.15 to 0.5	CVP and current probe	Average / 9 kHz	74 to 64	30 to 20
0.5 to 30			64	20
0.15 to 0.5	Current Probe	Quasi Peak / 9 kHz	N/A	40 to 30
0.5 to 30				30
0.15 to 0.5	Current Probe	Average / 9 kHz		30 to 20
0.5 to 30				20

#### 8.4. Test Procedure

The EUT is put on the plane 0.8m high above the ground by insulating support and connected to the AC mains through artificial mains network (AMN) or connected to the wired network port through an asymmetric artificial network (ANN). AMN provided a 50ohm coupling impedance for the tested equipment AC mains port, ANN provided a common mode (asymmetric mode) impedance of 150  $\Omega$  to the wired network port under test. The wired network line are investigated to find out the maximum conducted emission according to the EN 55032 regulations during conducted emission measurement.

The bandwidth of the receiver is set at 9 kHz in 150 kHz~30 MHz. The frequency range from 150 kHz to 30 MHz is investigated.

Test results were obtained from the following equation:  
Measurement (dB $\mu$ V) =Correct Factor (dB) + Reading (dB $\mu$ V)  
Over (dB) = Measurement (dB $\mu$ V) - Limit (dB $\mu$ V)

#### 8.5. Measuring Results

**PASS.**

All the modes were tested and the data of the worst modes are attached the following pages.

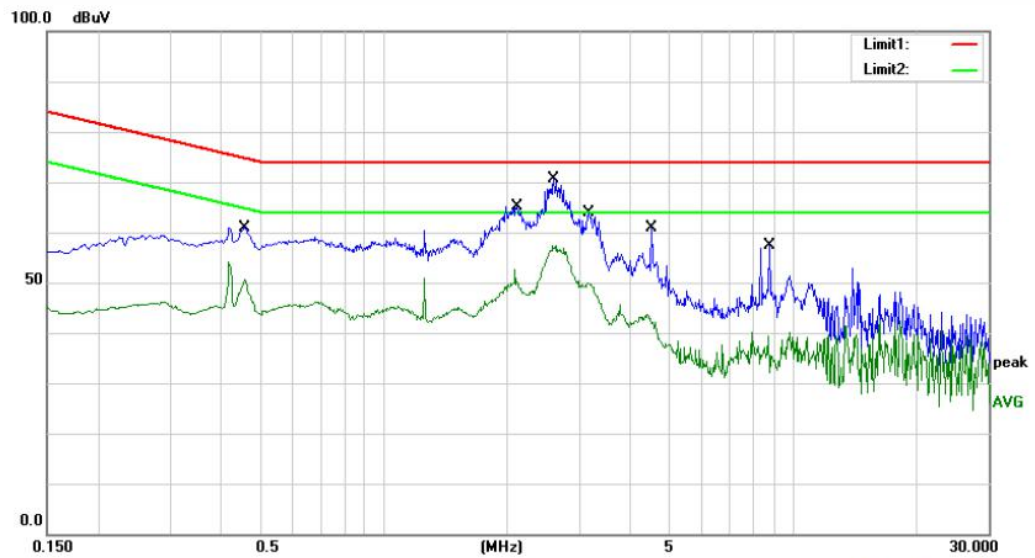

Site site #1 Phase: Temperature: 24  
 Limit: (CE)EN 55032 Class B TELECOM\_QP Power: AC 230V/50Hz Humidity: 50 %  
 Mode: WIFI Control  
 Note:

No.	Mk.	Freq. MHz	Reading Level dBuV	Correct Factor dB	Measure- ment dBuV	Limit dBuV	Over dB	Detector	Comment
1		0.4580	35.90	19.84	55.74	74.73	-18.99	QP	
2		0.4580	30.30	19.84	50.14	64.73	-14.59	AVG	
3		2.1140	39.80	19.67	59.47	74.00	-14.53	QP	
4		2.1140	30.10	19.67	49.77	64.00	-14.23	AVG	
5		2.5980	45.20	19.71	64.91	74.00	-9.09	QP	
6	*	2.5980	36.90	19.71	56.61	64.00	-7.39	AVG	
7		3.1620	37.40	19.75	57.15	74.00	-16.85	QP	
8		3.1620	29.80	19.75	49.55	64.00	-14.45	AVG	
9		4.5140	28.40	19.85	48.25	74.00	-25.75	QP	
10		4.5140	21.90	19.85	41.75	64.00	-22.25	AVG	
11		8.7460	24.50	19.90	44.40	74.00	-29.60	QP	
12		8.7460	19.40	19.90	39.30	64.00	-24.70	AVG	



## 9. RADIATED EMISSION

### 9.1. Block Diagram of Test Setup

Below 1GHz

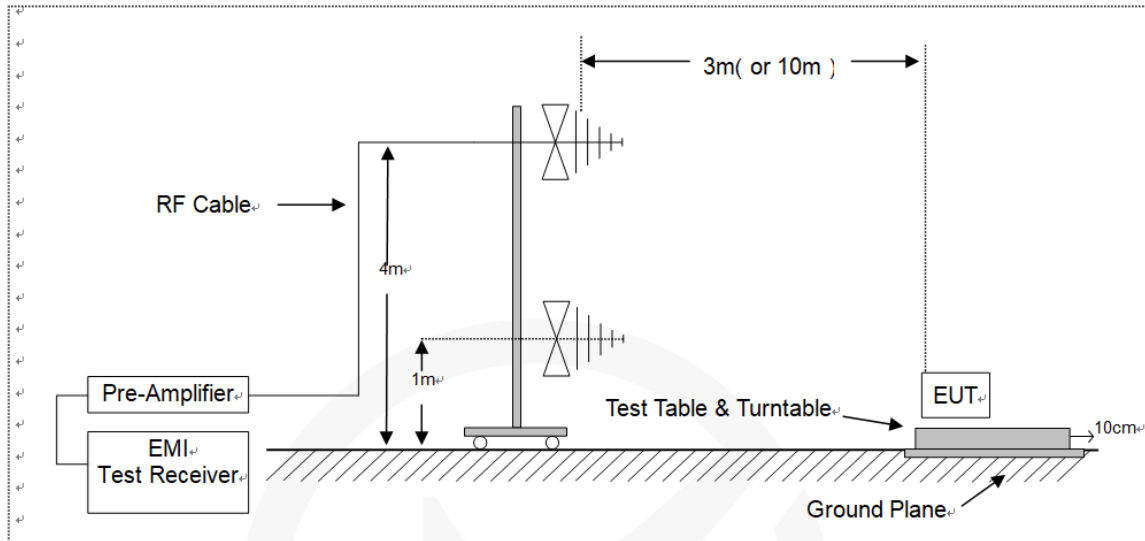

Above 1GHz

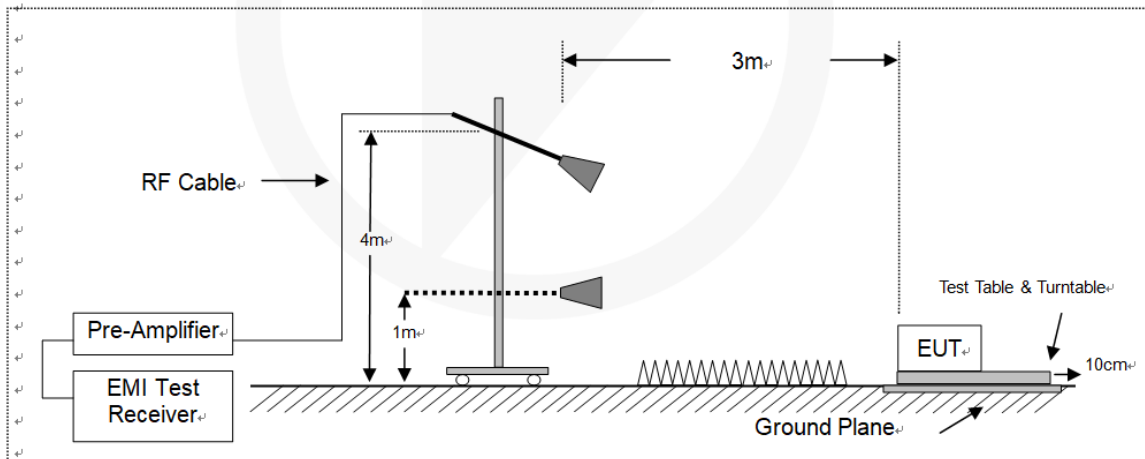

### 9.2. Measuring Standard

ETSI EN 301 489-1 Clause 8.2  
EN 55032: 2015 Clause A.2

### 9.3. Radiated Limit

EN 55032, Class B, Table A.4 and A.5

Table clause	Frequency range MHz	Measurement			Class B limits dB(mV/m)
		Facility (see Table A.1)	Distance m	Detector type /bandwidth	
A4.1	30 to 230	OATS/SAC	10	Quasi Peak / 120 kHz	30
	230 to 1 000				37
A4.2	30 to 230	OATS/SAC	3		40
	230 to 1 000				47
A4.3	30 to 230	FAR	10	Quasi Peak / 120 kHz	32 to 25
	230 to 1 000				32
A4.4	30 to 230	FAR	3		42 to 35
	230 to 1 000				42

Apply only table clause A4.1 or A4.2 or A4.3 or A4.4 across the entire frequency range. These requirements are not applicable to the local oscillator and harmonics frequencies of equipment covered by Table A.6.

Table clause	Frequency range MHz	Measurement			Class B limits dB(mV/m)
		Facility (see Table A.1)	Distance m	Detector type /bandwidth	
A5.1	1 000 to 3 000	FSOATS	3	Average/ 1 MHz	50
	3 000 to 6 000				54
A5.2	1 000 to 3 000			Peak/ 1 MHz	70
	3 000 to 6 000				74

Apply A5.1 and A5.2 across the frequency range from 1 000 MHz to the highest required frequency of measurement derived from Table 1.

### 9.4. Test Procedure

The EUT was placed on a non-conductive table whose total height equaled 80cm. All units of equipment forming the system under test (includes the EUT as well as connected peripherals and associated equipment or devices) shall be arranged such that a nominal 0.1 m separation is achieved between the neighboring units. Where the mains cable supplied by the manufacturer is longer than 1 m, the excess should be folded at the centre into a bundle no longer than 0.4 m, so that its length is shortened to 1 m.

The EUT was set 3 meters (or 10 meters) away from the receiving antenna that was mounted on a non-conductive mast. The antenna can move up and down between 1 to 4 meters to find out the maximum emission level.

The turntable can rotate 360 degree to determine the position of the maximum emission level.

The initial testing identified the frequency that has the highest disturbance relative to the limit while operating the EUT in typical modes of operation and cable positions in a test setup representative of typical system configuration.

The identification of the frequency of highest emission with respect to the limit was found by investigating emissions at a number of significant frequencies. The probable frequency of maximum emission had been found and that the associated cable and EUT configuration and mode of operation had been identified.

The 30 MHz-1GHz bandwidth of the Receiver is set at 120 kHz, above 1GHz Receiver is set at 1MHz

Test results were obtained from the following equation:  
Measurement (dB $\mu$ V) =Correct Factor (dB) + Reading (dB $\mu$ V)  
Over (dB) = Measurement (dB $\mu$ V) - Limit (dB $\mu$ V)

## 9.5. Measuring Results

**PASS.**

All the modes were tested and the data of the worst modes are attached the following pages.





Site Radiated Emission 3m #1      Polarization: **Horizontal**      Temperature: 24  
 Limit: (RE)EN 55032 class B\_3M      Power: AC 230V/50Hz      Humidity: 55 %  
 Mode:WIFI Control  
 Note:

No.	Mk.	Freq. MHz	Reading Level dBuV	Correct Factor dB	Measure- ment dBuV/m	Limit dBuV/m	Over dB	Antenna Height cm	Table Degree degree	Comment
1		54.4515	46.12	-21.12	25.00	40.00	-15.00	QP		
2		85.5974	58.90	-26.60	32.30	40.00	-7.70	QP		
3		155.3642	60.81	-27.01	33.80	40.00	-6.20	QP		
4		276.1234	59.41	-20.61	38.80	47.00	-8.20	QP		
5		362.9844	59.24	-19.24	40.00	47.00	-7.00	QP		
6	*	776.8778	53.26	-9.66	43.60	47.00	-3.40	QP		

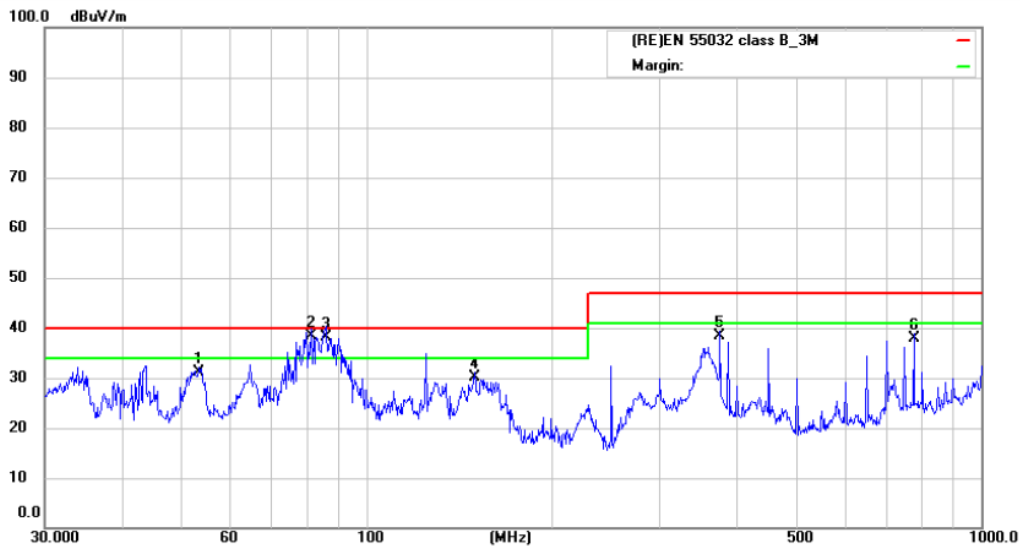

Site Radiated Emission 3m #1      Polarization: **Vertical**      Temperature: 24  
 Limit: (RE)EN 55032 class B\_3M      Power: AC 230V/50Hz      Humidity: 55 %  
 Mode:WIFI Control  
 Note:

No.	Mk.	Freq. MHz	Reading Level dBuV	Correct Factor dB	Measure- ment dBuV/m	Limit dBuV/m	Over dB	Detector	Antenna Height cm	Table Degree degree	Comment
1		53.5052	52.21	-21.01	31.20	40.00	-8.80	QP			
2	*	81.2116	65.88	-27.48	38.40	40.00	-1.60	QP			
3	!	85.8984	64.67	-26.47	38.20	40.00	-1.80	QP			
4		150.0107	56.33	-26.23	30.10	40.00	-9.90	QP			
5		375.9384	56.71	-18.41	38.30	47.00	-8.70	QP			
6		776.8777	47.66	-9.66	38.00	47.00	-9.00	QP			

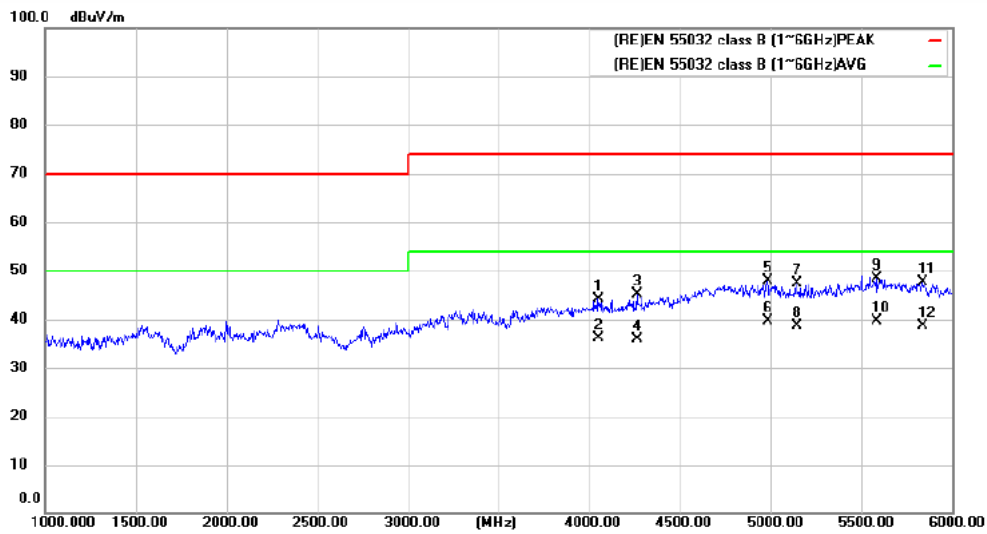

Site Radiated Emission 3m #1      Polarization: **Vertical**      Temperature: 24  
 Limit: (RE)EN 55032 class B (1~6GHz)PEAK      Power: AC 230V/50Hz      Humidity: 55 %  
 Mode:WIFI Control  
 Note:

No. Mk.	Freq. MHz	Reading Level dBuV	Correct Factor dB	Measure- ment dBuV/m	Limit dBuV/m	Over dB	Antenna Height cm	Table Degree	Detector	Comment
1	4049.020	55.17	-11.07	44.10	74.00	-29.90			QP	
2	4049.020	47.27	-11.07	36.20	54.00	-17.80			AVG	
3	4264.706	55.86	-10.76	45.10	74.00	-28.90			QP	
4	4264.706	46.66	-10.76	35.90	54.00	-18.10			AVG	
5	4975.490	56.83	-9.03	47.80	74.00	-26.20			QP	
6 *	4975.490	48.63	-9.03	39.60	54.00	-14.40			AVG	
7	5137.255	56.01	-8.61	47.40	74.00	-26.60			QP	
8	5137.255	47.31	-8.61	38.70	54.00	-15.30			AVG	
9	5583.333	55.81	-7.51	48.30	74.00	-25.70			QP	
10	5583.333	47.11	-7.51	39.60	54.00	-14.40			AVG	
11	5833.333	54.50	-6.90	47.60	74.00	-26.40			QP	
12	5833.333	45.60	-6.90	38.70	54.00	-15.30			AVG	

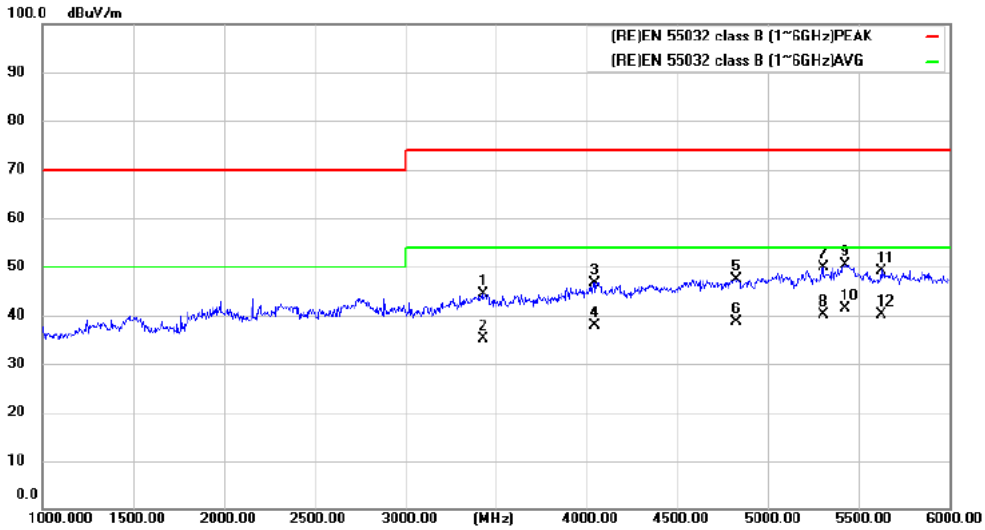

Site Radiated Emission 3m #1      Polarization: **Horizontal**      Temperature: 24  
 Limit: (RE)EN 55032 class B (1~6GHz)PEAK      Power: AC 230V/50Hz      Humidity: 55 %

Mode:WIFI Control  
 Note:

No. Mk.	Freq. MHz	Reading Level dBuV	Correct Factor dB	Measure- ment dBuV/m	Limit dBuV/m	Over dB	Detector	Antenna Height cm	Table Degree degree	Comment
1	3426.470	58.96	-14.66	44.30	74.00	-29.70	QP			
2	3426.470	49.86	-14.66	35.20	54.00	-18.80	AVG			
3	4044.118	57.78	-11.08	46.70	74.00	-27.30	QP			
4	4044.118	48.88	-11.08	37.80	54.00	-16.20	AVG			
5	4818.627	56.89	-9.49	47.40	74.00	-26.60	QP			
6	4818.627	48.09	-9.49	38.60	54.00	-15.40	AVG			
7	5303.922	57.99	-8.19	49.80	74.00	-24.20	QP			
8	5303.922	48.29	-8.19	40.10	54.00	-13.90	AVG			
9	5421.569	58.31	-7.91	50.40	74.00	-23.60	QP			
10 *	5421.569	49.21	-7.91	41.30	54.00	-12.70	AVG			
11	5622.549	56.61	-7.41	49.20	74.00	-24.80	QP			
12	5622.549	47.51	-7.41	40.10	54.00	-13.90	AVG			

## 10. HARMONIC CURRENT EMISSION MEASUREMENT

### 10.1. Block Diagram of Test Setup

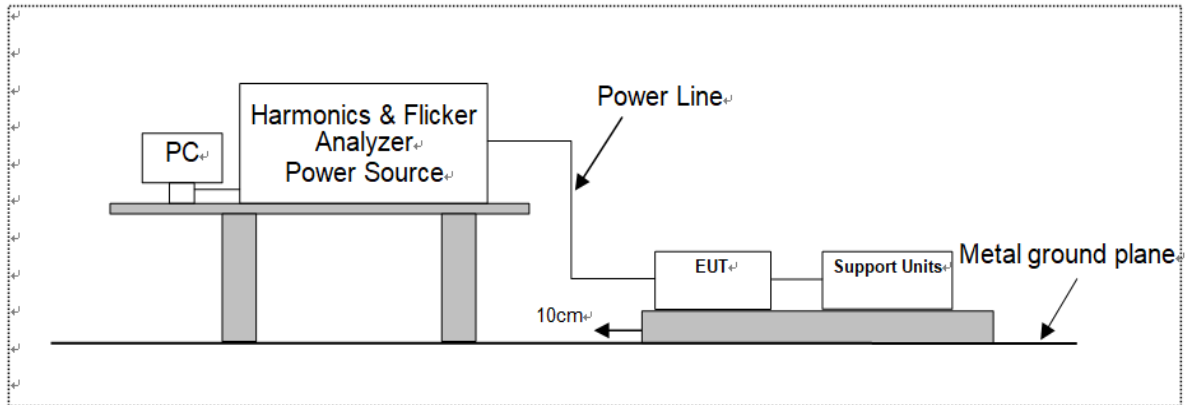

### 10.2. Measuring Standard

ETSI EN 301 489-1 Clause 8.5  
EN IEC 61000-3-2:2019

### 10.3. Standard Limits

EN 61000-3-2, CLASS A

Harmonic current emissions evaluate the potential for the EUT to cause distortion on the AC power lines. It is applicable to electrical and electronic equipment having an input current  $\leq 16$  A per phase, and intended to be connected to public low-voltage distribution systems

Table 1 - Limits for Class A equipment

Harmonic order n	Maximum permissible harmonic current (A)
Odd harmonics	
3	2.30
5	1.14
7	0.77
9	0.40
11	0.33
13	0.21
$15 \leq n \leq 39$	$0.15 \frac{0.15}{n}$
Even harmonics	
2	1.08
4	0.43
6	0.30
$8 \leq n \leq 40$	$0.23 \frac{8}{n}$



#### 10.4. Test Procedure

The measurement of harmonic currents shall be performed as follows: i. For each harmonic order, measure the 1.5 s smoothed r.m.s. harmonic current in each DFT time window as defined in EN / IEC 61000-4-7:2009. ii. Calculate the arithmetic average of the measured values from the DFT time windows, over the entire observation period Short cyclic ( $T_{\text{cycle}} \leq 2.5 \text{ min}$ ). Because of synchronisation to meet the requirements for repeatability in 5%.

#### 10.5. Test Results

**PASS.**



## Harmonics – Class-A per IEC 61000-3-2 (Run time)

EUT: Datahub(Datahub1000)

Test category: Class-A (European limits)

Test date: 2021/12/1

Test duration (min): 2.5

Comment: ON

Customer: Customer

Tested by: LSL

Test Margin: 100

End time: 10:39:00

Start time: 10:36:19

Data file name: H-000222.cts\_data

Test Result: Pass

Source qualification: Normal

### Current & voltage waveforms

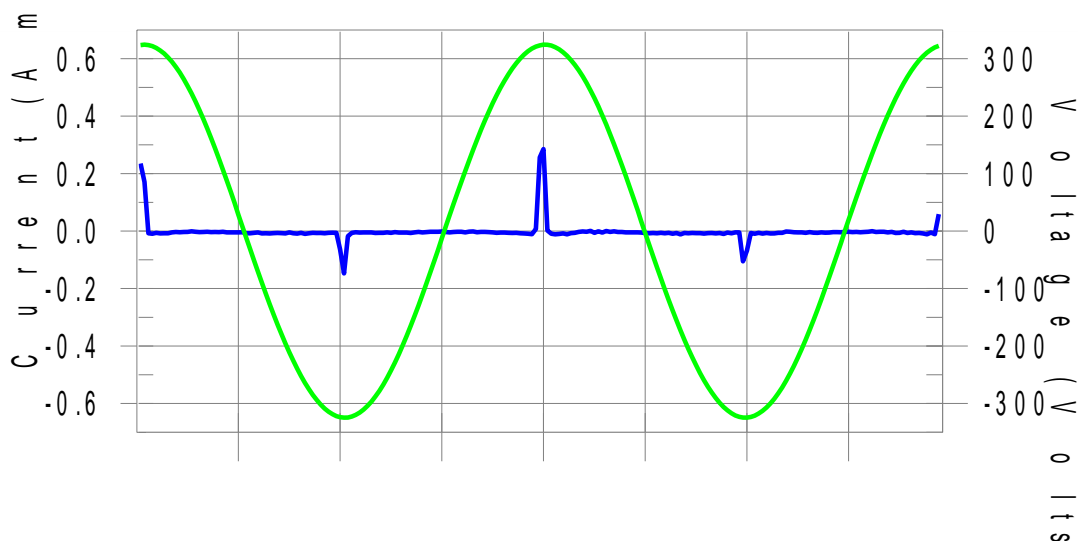

### Harmonics and Class A limit line

### European Limits

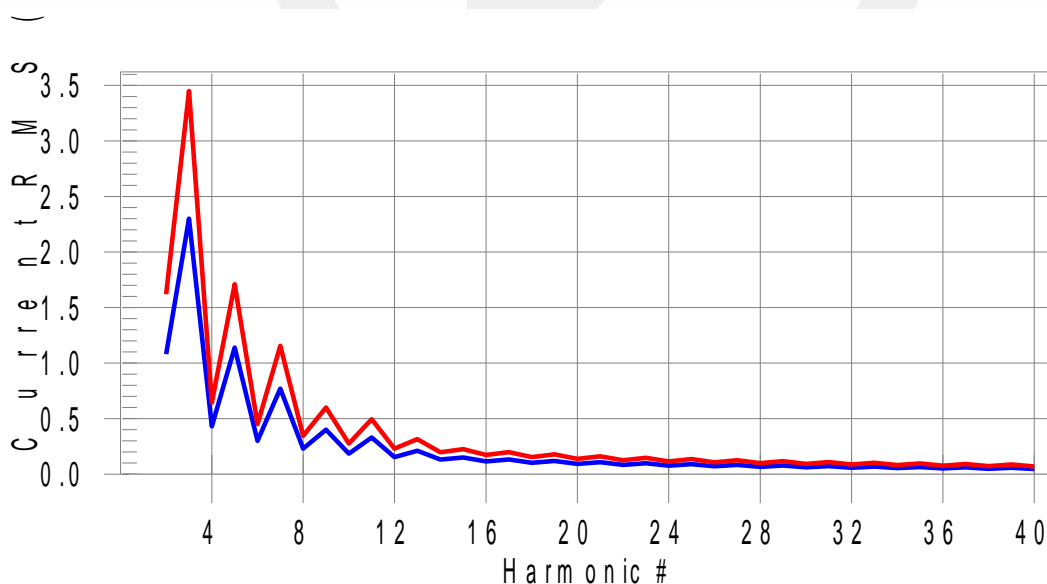

**Test result: Pass Worst harmonics H23-3.8% of 150% limit, H23-5.5% of 100% limit**

### Current Test Result Summary (Run time)

EUT: Datahub(Datahub1000)      Tested by: LSL  
 Test category: Class-A (European limits)      Test Margin: 100  
 Test date: 2021/12/1      Start time: 10:36:19      End time: 10:39:00  
 Test duration (min): 2.5      Data file name: H-000222.cts\_data  
 Comment: ON  
 Customer: Customer

Test Result: Pass      Source qualification: Normal  
 THC(A): 0.030      I-THD(%): 357.5      POHC(A): 0.013      POHC Limit(A): 0.251

Highest parameter values during test:

V\_RMS (Volts): 229.72      Frequency(Hz): 50.00  
 I\_Peak (Amps): 0.335      I\_RMS (Amps): 0.034  
 I\_Fund (Amps): 0.008      Crest Factor: 10.304  
 Power (Watts): 1.9      Power Factor: 0.263

Harm#	Harms(avg)	100%Limit	%of Limit	Harms(max)	150%Limit	%of Limit	Status
2	0.005	1.080	N/A	0.006	1.620	N/A	Pass
3	0.008	2.300	0.3	0.009	3.450	0.3	Pass
4	0.005	0.430	N/A	0.005	0.645	N/A	Pass
5	0.008	1.140	0.7	0.008	1.710	0.5	Pass
6	0.005	0.300	N/A	0.005	0.450	N/A	Pass
7	0.008	0.770	1.0	0.008	1.155	0.7	Pass
8	0.004	0.230	N/A	0.005	0.345	N/A	Pass
9	0.007	0.400	1.8	0.008	0.600	1.3	Pass
10	0.004	0.184	N/A	0.005	0.276	N/A	Pass
11	0.007	0.330	2.2	0.008	0.495	1.6	Pass
12	0.004	0.153	N/A	0.005	0.230	N/A	Pass
13	0.007	0.210	3.3	0.007	0.315	2.3	Pass
14	0.004	0.131	N/A	0.005	0.197	N/A	Pass
15	0.007	0.150	4.4	0.007	0.225	3.1	Pass
16	0.004	0.115	N/A	0.004	0.173	N/A	Pass
17	0.006	0.132	4.8	0.007	0.198	3.4	Pass
18	0.004	0.102	N/A	0.004	0.153	N/A	Pass
19	0.006	0.118	5.1	0.006	0.178	3.6	Pass
20	0.004	0.092	N/A	0.004	0.138	N/A	Pass
21	0.006	0.107	5.3	0.006	0.161	3.7	Pass
22	0.004	0.084	N/A	0.004	0.125	N/A	Pass
23	0.005	0.098	5.5	0.006	0.147	3.8	Pass
24	0.003	0.077	N/A	0.004	0.115	N/A	Pass
25	0.005	0.090	N/A	0.005	0.135	N/A	Pass
26	0.003	0.071	N/A	0.003	0.107	N/A	Pass
27	0.005	0.083	N/A	0.005	0.125	N/A	Pass
28	0.003	0.066	N/A	0.003	0.099	N/A	Pass
29	0.004	0.078	N/A	0.004	0.116	N/A	Pass
30	0.003	0.061	N/A	0.003	0.092	N/A	Pass
31	0.004	0.073	N/A	0.004	0.109	N/A	Pass
32	0.003	0.058	N/A	0.003	0.086	N/A	Pass
33	0.003	0.068	N/A	0.004	0.102	N/A	Pass
34	0.002	0.054	N/A	0.003	0.081	N/A	Pass
35	0.003	0.064	N/A	0.003	0.096	N/A	Pass
36	0.002	0.051	N/A	0.002	0.077	N/A	Pass
37	0.003	0.061	N/A	0.003	0.091	N/A	Pass
38	0.002	0.048	N/A	0.002	0.073	N/A	Pass
39	0.002	0.058	N/A	0.002	0.087	N/A	Pass
40	0.002	0.046	N/A	0.002	0.069	N/A	Pass

## Voltage Source Verification Data (Run time)

EUT: Datahub(Datahub1000) Tested by: LSL  
Test category: Class-A (European limits) Test Margin: 100  
Test date: 2021/12/1 Start time: 10:36:19 End time: 10:39:00  
Test duration (min): 2.5 Data file name: H-000222.cts\_data  
Comment: ON  
Customer: Customer

Test Result: Pass Source qualification: Normal

### Highest parameter values during test:

Voltage (Vrms): 229.72 Frequency(Hz): 50.00  
I\_Peak (Amps): 0.335 I\_RMS (Amps): 0.034  
I\_Fund (Amps): 0.008 Crest Factor: 10.304  
Power (Watts): 1.9 Power Factor: 0.263

Harm#	Harmonics V-rms	Limit V-rms	% of Limit	Status
2	0.081	0.459	17.66	OK
3	0.587	2.067	28.38	OK
4	0.057	0.459	12.47	OK
5	0.069	0.919	7.49	OK
6	0.022	0.459	4.78	OK
7	0.024	0.689	3.54	OK
8	0.018	0.459	3.85	OK
9	0.039	0.459	8.49	OK
10	0.010	0.459	2.11	OK
11	0.020	0.230	8.82	OK
12	0.010	0.230	4.25	OK
13	0.014	0.230	6.13	OK
14	0.006	0.230	2.52	OK
15	0.013	0.230	5.45	OK
16	0.009	0.230	3.97	OK
17	0.009	0.230	4.11	OK
18	0.010	0.230	4.27	OK
19	0.011	0.230	4.99	OK
20	0.015	0.230	6.70	OK
21	0.011	0.230	4.71	OK
22	0.009	0.230	3.80	OK
23	0.009	0.230	3.89	OK
24	0.005	0.230	2.30	OK
25	0.009	0.230	3.84	OK
26	0.005	0.230	2.13	OK
27	0.007	0.230	3.13	OK
28	0.005	0.230	2.34	OK
29	0.009	0.230	3.77	OK
30	0.005	0.230	2.20	OK
31	0.007	0.230	3.22	OK
32	0.005	0.230	2.08	OK
33	0.008	0.230	3.32	OK
34	0.005	0.230	1.99	OK
35	0.007	0.230	2.99	OK
36	0.004	0.230	1.92	OK
37	0.007	0.230	3.10	OK
38	0.004	0.230	1.77	OK
39	0.007	0.230	3.21	OK
40	0.008	0.230	3.33	OK

## 11. VOLTAGE FLUCTUATION AND FLICKER MEASUREMENT

### 11.1. Block Diagram of Test Setup

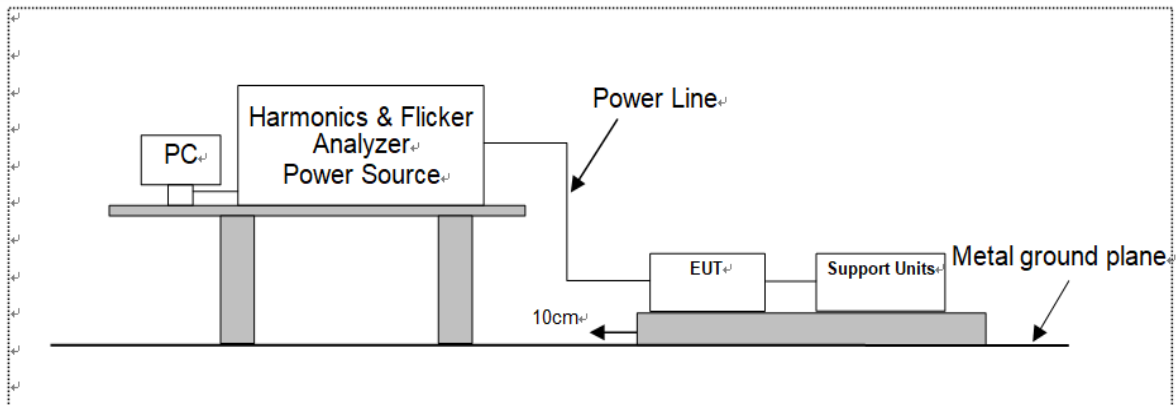

### 11.2. Measuring Standard

ETSI EN 301 489-1 Clause 8.6  
EN 61000-3-3:2013/ A1:2019

### 11.3. Standard Limits

EN 61000-3-3 Limits

The objective of voltage changes, voltage fluctuations and flicker in public low voltage supply systems during equipment with rated current  $\leq 16$  A per phase, ensures that home appliances and certain other electrical equipment do not adversely affect lighting equipment when connected to the same power system.

Voltage Fluctuation and Flicker Limits:

- the value of  $P_{st}$  shall not be greater than 1.0;
- the value of  $Plt$  shall not be greater than 0.65;
- the value of  $d(t)$  during a voltage change shall not exceed 3.3 % for more than 500 ms;
- the relative steady-state voltage change,  $d_c$ , shall not exceed 3.3 %;
- the maximum relative voltage change,  $d_{max}$ , shall not exceed 4.0 %;

### 11.4. Test Procedure

The total impedance of the test circuit, excluding the appliance under test, but including the internal impedance of the supply source, shall be equal to the reference impedance. The stability and tolerance of the reference impedance shall be adequate to ensure that the overall accuracy of 8% is achieved during the whole assessment procedure.

### 11.5. Test Results

**PASS.**

Please see the attached page.

## Flicker Test Summary per IEC61000-3-3 (Run time)

EUT: Datahub(Datahub1000)

Tested by: LSL

Test category: dt,dmax,dc and Pst (European limits)

Test Margin: 100

Test date: 2021/12/1

Start time: 10:39:53

End time: 10:50:21

Test duration (min): 10

Data file name: F-000223.cts\_data

Comment: ON

Customer: Customer

Test Result: Pass

Status: Test Completed

### Pst<sub>i</sub> and limit line

### European Limits

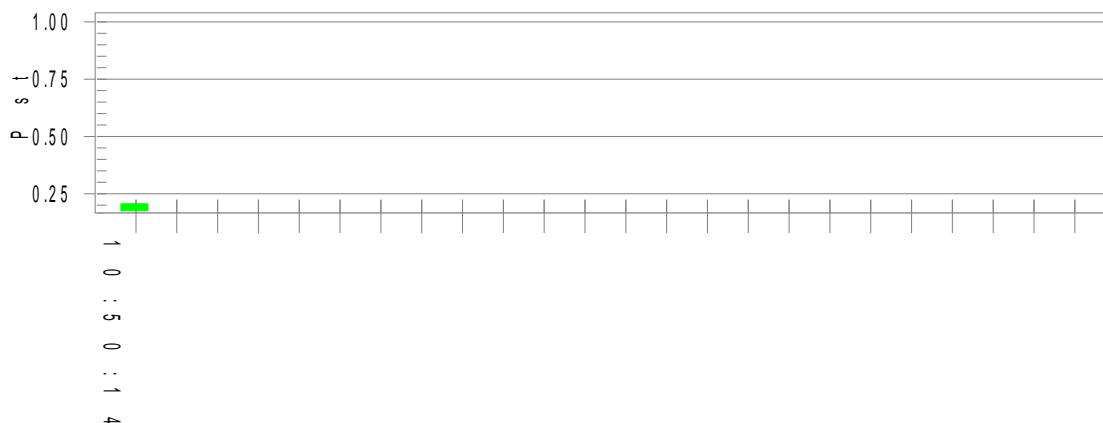

### Plt and limit line

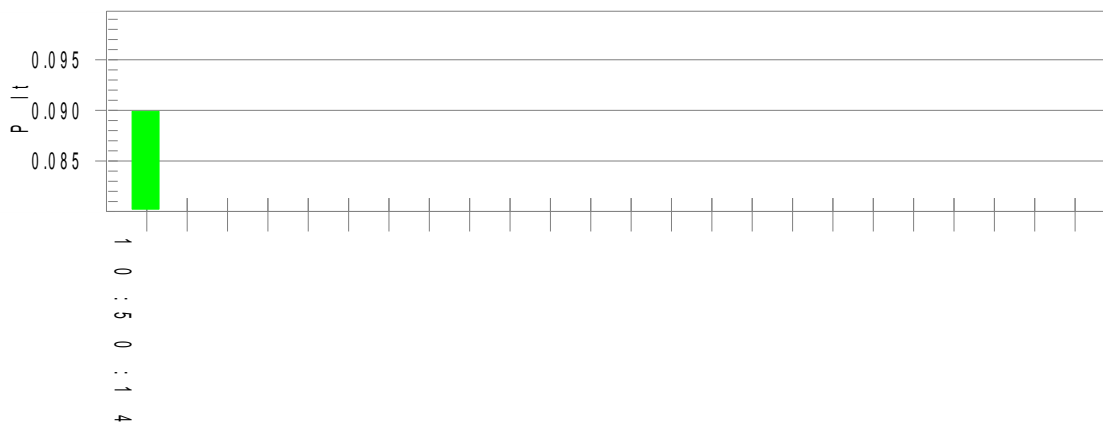

### Parameter values recorded during the test:

Vrms at the end of test (Volt): 229.62

Highest dt (%):

T-max (mS): 0

Highest dc (%): 0.00

Highest dmax (%): 0.00

Highest Pst (10 min. period): 0.206

Test limit (%):

Test limit (mS): 500.0 Pass

Test limit (%): 3.30 Pass

Test limit (%): 4.00 Pass

Test limit: 1.000 Pass

## 12. PERFORMANCE CRITERIA

### 12.1. General performance criteria

The performance criteria are:

- Performance criteria A for immunity tests with phenomena of a continuous nature;
- Performance criteria B for immunity tests with phenomena of a transient nature;
- Performance criteria C for immunity tests with power interruptions exceeding a certain time.

The equipment shall meet the minimum performance criteria as specified in the following clauses.

### 12.2. Performance table

#### ETSI 301 489-17 Performance criteria;

Criteria	During test	After test (i.e. as a result of the application of the test))
A	Shall operate as intended. (see note ). Shall be no loss of function. Shall be no unintentional transmissions.	Shall operate as intended. Shall be no degradation of performance. Shall be no loss of function. Shall be no loss of critical stored data.
B	May be loss of function	Functions shall be self-recoverable. Shall operate as intended after recovering. Shall be no loss of critical stored data.
C	May be loss of function.	Functions shall be recoverable by the operator. Shall operate as intended after recovering. Shall be no loss of critical stored data.
NOTE: Operate as intended during the test allows a level of degradation in accordance with clause 6.2.2.		

#### Minimum performance level

For equipment that supports a PER or FER, the minimum performance level shall be a PER or FER less than or equal to 10 %.

For equipment that does not support a PER or a FER, the minimum performance level shall be no loss of the wireless transmission function needed for the intended use of the equipment.

#### Performance criteria for Continuous phenomena

The performance criteria A shall apply.

Where the EUT is a transmitter in standby mode, unintentional transmission shall not occur during the test.

Where the EUT is a transceiver in receive mode, unintentional transmission shall not occur during the test.

#### Performance criteria for Transient phenomena

The performance criteria B shall apply, except for voltage dips greater than or equal to 100 ms and voltage interruptions of 5 000 ms duration, for which performance criteria C shall apply.

Where the EUT is a transmitter in standby mode, unintentional transmission shall not occur as a result of the application of the test.

Where the EUT is a transceiver in receive mode, unintentional transmission shall not occur as a result of the application of the test.

## 13. ELECTROSTATIC DISCHARGE

### 13.1. Test Specification

Test standard	: ETSI EN 301 489-1
Basic standard	: EN 61000-4-2
Performance criterion	: B
Test level	: $\pm 8.0\text{kV}$ (Air discharge) $\pm 4.0\text{kV}$ (Contact discharge)

### 13.2. Block Diagram of Test Setup

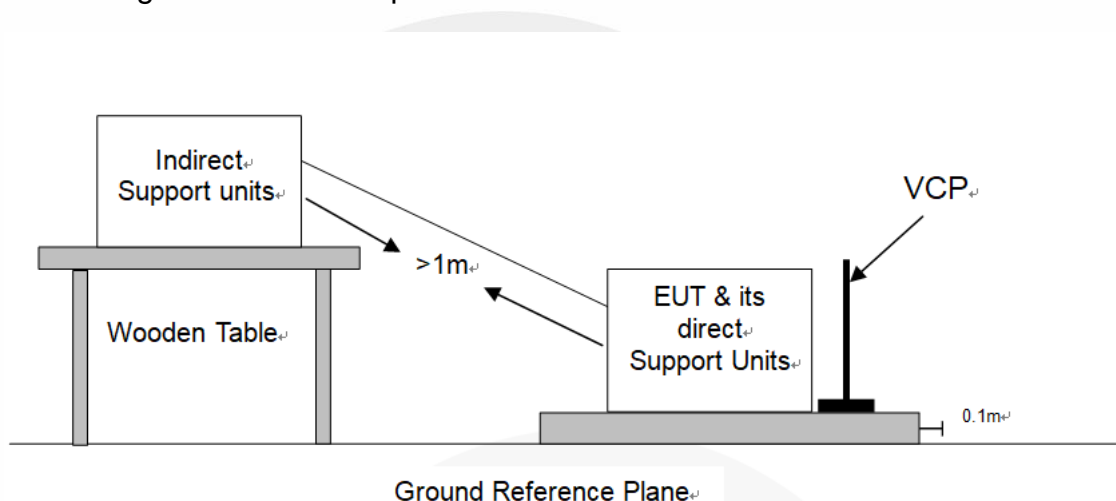

### 13.3. Test Procedure

Please refer to ETSI EN 301 489-1 Clause 9.3.2 and EN 61000-4-2 for the measurement methods.

- In the case of air discharge testing, the climatic conditions shall be within the following ranges:
  - ambient temperature:  $15^{\circ}\text{C}$  to  $35^{\circ}\text{C}$ ;
  - relative humidity : 30% to 60%;
  - atmospheric pressure : 86 kPa (860 mbar) to 106 kPa (1060 mbar)
- Test programs and software shall be chosen so as to exercise all normal modes of operation of the EUT. The use of special exercising software is encouraged, but permitted only where it can be shown that the EUT is being comprehensively exercised.
- In the case of contact discharges, the tip of the discharge electrode shall touch the EUT before the discharge switch is operated.
- In the case of painted surface covering a conducting substrate, the following procedure shall be adopted :
  - If the coating is not declared to be an insulating coating by the equipment manufacturer, then the pointed tip of the generator shall penetrate the coating so as to make contact with the conducting substrate.
  - Coating declared as insulating by the manufacturer shall only be submitted to the air discharge.
  - The contact discharge test shall not be applied to such surfaces.
- In the case of air discharges, the round discharge tip of the discharge electrode shall be approached as fast as possible (without causing mechanical damage) to touch the EUT. After each discharge, the ESD generator (discharge electrode) shall be removed from the EUT. The generator is then retriggered for a new single discharge. This procedure shall be repeated until the discharges are completed. In the case of an air discharge test, the discharge switch, which is used for contact



discharge, shall be closed.

f. The test voltage shall be increased from the minimum to the selected test severity level, in order to determine any threshold of failure. The final test level should not exceed the product specification value in order to avoid damage to the equipment.

g. The test shall be performed with both air discharge and contact discharge. The test shall be performed with single discharges. On each pre-selected point at least 10 single discharges (in the most sensitive polarity) shall be applied. For the time interval between successive single discharges an initial value of 1 s is recommended. Longer intervals may be necessary to determine whether a system failure has occurred.

h. Ensure that the applied charge on the EUT has been dis-charged before next ESD pulse.

i. At least ten single discharges (in the most sensitive polarity) were applied to the Horizontal Coupling Plane at points on each side of the Product. The ESD generator was positioned vertically at a distance of 0.1 meters from the Product with the discharge electrode touching the HCP.

J. At least ten single discharges (in the most sensitive polarity) were applied to the center of one vertical edge of the Vertical Coupling Plane in sufficiently different positions that the four faces of the Product were completely illuminated. The VCP (dimensions 0.5m x 0.5m) was placed vertically to and 0.1 meters from the Product.

#### 13.4. Test Results



**PASS**

Temperature : 22°C  
 Humidity : 47%  
 Atmospheric Pressure : 101kpa  
 Test Engineer : LSL  
 Test Date : 2021-12-1

**Air Discharge:**

Test Voltage	Location	Actual criterion	Required performance criterion	Result (Pass/Fail)
±2; 4; 8 kV	Non-Conducted Enclosure	A	B	Pass
±2; 4; 8 kV	/	/	/	/
±2; 4; 8 kV	/	/	/	/

**Contact Discharge**

Test Voltage	Location	Actual criterion	Required performance criterion	Result (Pass/Fail)
±2; 4kV	All slots of the EUT	A	B	Pass
±2; 4kV	Conducted Enclosure	A	B	Pass
±2; 4kV	Screw	A	B	Pass

**Indirect Discharge**

Test Voltage	Location	Actual criterion	Required performance criterion	Result (Pass/Fail)
±2kV, ±4kV	HCP	A	B	Pass
±2kV, ±4kV	VCP	A	B	Pass

## 14. CONTINUOUS RF ELECTROMAGNETIC FIELD DISTURBANCES

### 14.1. Test Specification

Test standard	: ETSI EN 301 489-1	
Basic standard	: EN 61000-4-3	
Performance criterion	: A	
Frequency range & Test level	: <input checked="" type="checkbox"/> 80M-6000MHz	3V/m
	<input type="checkbox"/> Spot frequency	3V/m
	<input type="checkbox"/> Additional spot frequency	3V/m
Modulation	: AM, 80%, 1kHz sine-wave	

### 14.2. Block Diagram of Test Setup

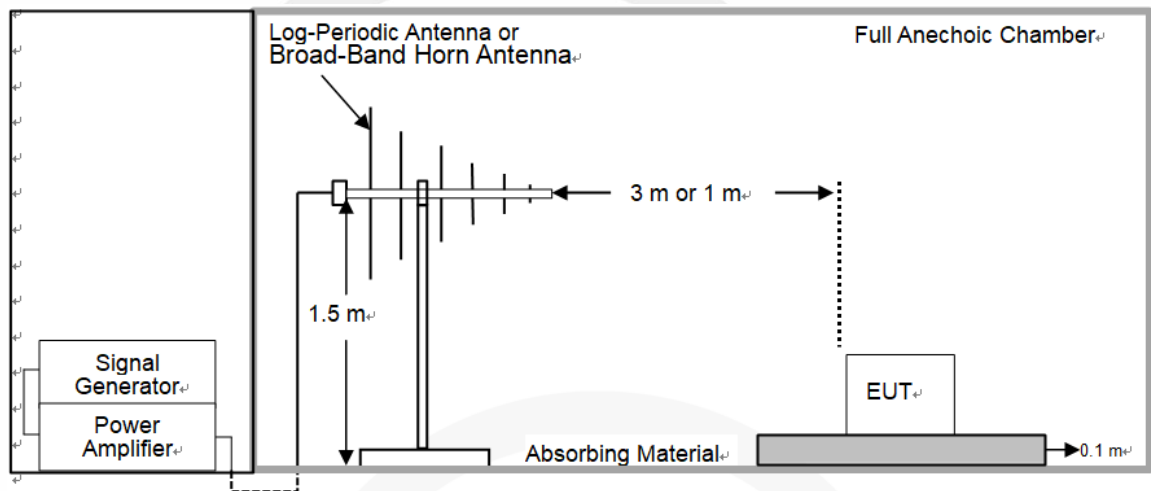

### 14.3. Test procedure

Please refer to ETSI EN 301 489-1 Clause 9.2.2 and EN 61000-4-3 for the measurement methods. The procedure defined in this part requires the generation of electromagnetic fields within which the test sample is placed and its operation observed. To generate fields that are useful for simulation of actual (field) conditions may require significant antenna drive power and the resultant high field strength levels. To comply with local regulations and to prevent biological hazards to the testing personnel, it is recommended that these tests be carried out in a shielded enclosure or semi-anechoic chamber.

The test level shall be 3 V/m (measured undulated). The test signal shall be amplitude modulated to a depth of 80 % by a sinusoidal audio signal of 1 000 Hz. If the wanted signal is modulated at 1 000 Hz, then an audio signal of 400 Hz shall be used;

The test shall be performed over the frequency range 80 MHz to 6 000 MHz with the exception of the exclusion band for transmitters, receivers and duplex transceivers (see clause 4.3), as appropriate; For receivers and transmitters the stepped frequency increments shall be 1 % frequency increment of the momentary used frequency;

The dwell time of the test phenomena at each frequency shall not be less than the time necessary for the EUT to be exercised and to be able to respond;

The test is performed with the antenna facing the front and back sides of the EUT with. Both vertical and horizontal polarizations from antenna are tested.

#### 14.4. Test results

##### PASS

Temperature : 21°C  
 Humidity : 48%  
 Atmospheric Pressure : 101kpa  
 Test Engineer : CSL  
 Test Date : 2021-12-3

80M-6000MHZ:

Freq. Range (MHz)	Field	Modulation	Polarity	Position (°)	Actual criterion	Required performance criterion	Result
80-6000	3V/m	AM, 80%	H / V	0, 90,180, 270	A	A	Pass



## 15. ELECTRICAL FAST TRANSIENTS/BURST

### 15.1. Test Specification

Test standard	: ETSI EN 301 489-1
Basic standard	: EN 61000-4-4
Performance criterion	: B
Test level	: <input checked="" type="checkbox"/> 1kV, AC mains power ports <input type="checkbox"/> 0.5kV, DC network power ports <input type="checkbox"/> 0.5kV, Analogue/digital data ports
Repetition frequency	: <input checked="" type="checkbox"/> 5kHz, <input type="checkbox"/> 100kHz(Only xDSL ports)
Tr/Th:	: 5/50ns
Burst period	: 300ms
Test time :	: 120s

### 15.2. Block Diagram of Test Setup

AC Lines:

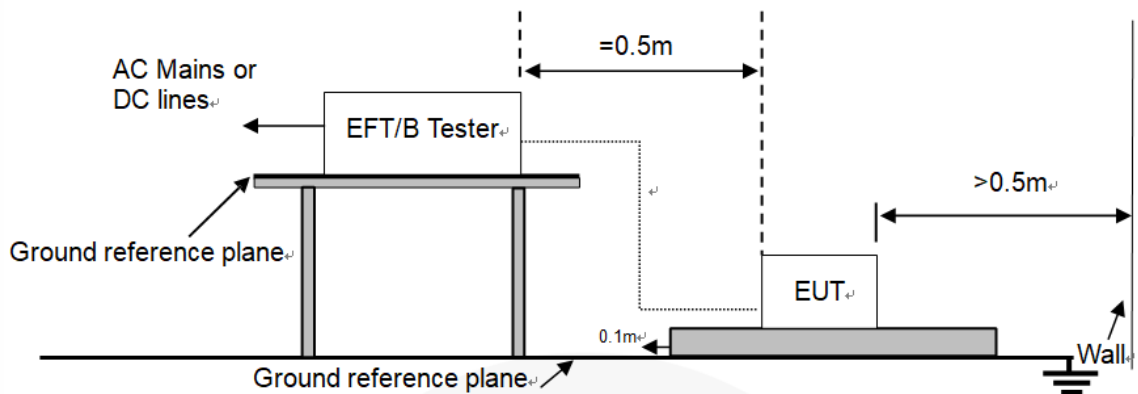

Signal lines:

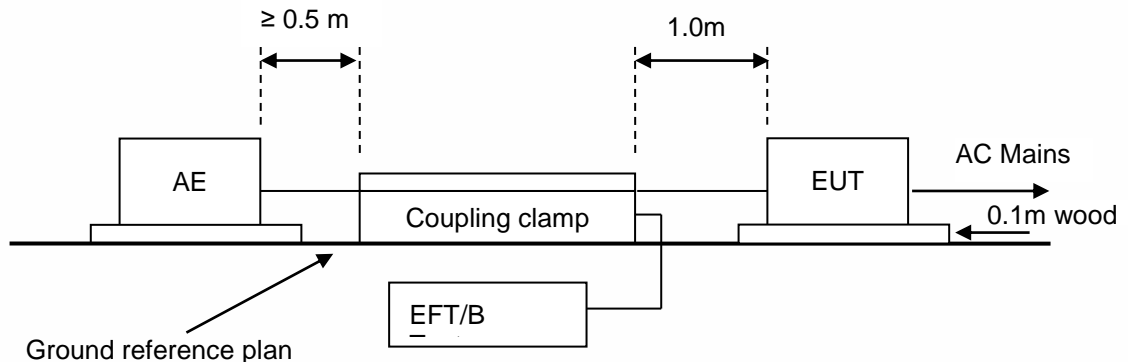

### 15.3. Test Procedure

Please refer to ETSI EN 301 489-1 Clause 9.4.2 and EN 61000-4-4 for the measurement methods. The EUT is put on the table that is 0.8 meter high above the ground. This reference ground plane shall project beyond the EUT by at least 0.1m on all sides and the minimum distance between EUT and all other conductive structure, except the ground plane beneath the EUT, shall be more than 0.5m.

### 15.4. Test Results

#### PASS

Temperature : 25°C  
 Humidity : 49%  
 Atmospheric Pressure : 101kpa  
 Test Engineer : LSL  
 Test Date : 2021-12-1

Injection Line	Voltage (kV)	Injected Method	Actual criterion	Required performance criterion	Result (Pass/Fail)
<input checked="" type="checkbox"/> AC mains power ports	± 1	<input type="checkbox"/> CDN <input checked="" type="checkbox"/> Direct injection <input type="checkbox"/> Capacitive coupling clamp	A	B	Pass
<input type="checkbox"/> DC network power ports	± 0.5	<input type="checkbox"/> CDN <input type="checkbox"/> Direct injection <input type="checkbox"/> Capacitive coupling clamp	N/A	N/A	N/A
<input checked="" type="checkbox"/> Analogue/digital data ports (Wired network port)	± 0.5	<input type="checkbox"/> CDN <input type="checkbox"/> Direct injection <input type="checkbox"/> Capacitive coupling clamp	N/A	N/A	N/A
<input type="checkbox"/> Analogue/digital data ports (Signal Line)	± 0.5	<input type="checkbox"/> CDN <input type="checkbox"/> Direct injection <input checked="" type="checkbox"/> Capacitive coupling clamp	A	B	Pass

## 16. SURGES

### 16.1. Test Specification

Test standard	: ETSI EN 301 489-1
Basic standard	: EN 61000-4-5
Test level	: <input checked="" type="checkbox"/> 1kV, Line to Line, AC mains power ports, Criterion B <input type="checkbox"/> 2kV, Line to Earth, AC mains power ports, Criterion B <input type="checkbox"/> 1.0kV, Lines to Ground, Unshielded symmetrical, Criterion B <input type="checkbox"/> 1.0kV, Lines to Ground, Unshielded non-symmetrically, Criterion B <input type="checkbox"/> 0.5kV, Shield to ground, Coaxial or shielded port, Criterion B
Number of surges	: 5 (for each combination of parameters)
Repetition rate	: 1 minute / time
Polarity:	: Positive / Negative
Phase angle:	: 90°, 270° (Only AC mains power ports)

### 16.2. Block Diagram of Test Setup

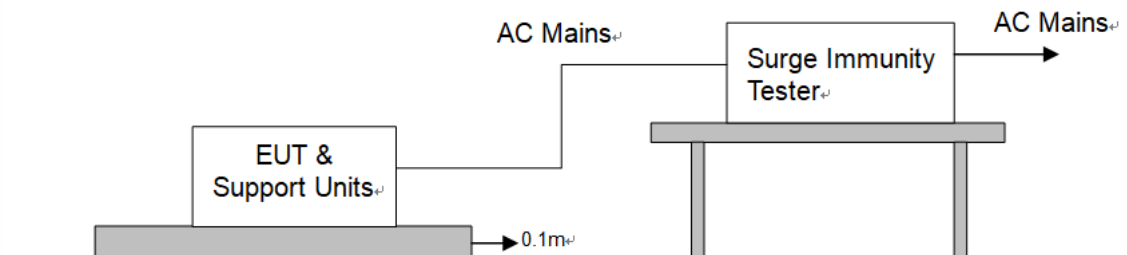

### 16.3. Test Procedure

Please refer to ETSI EN 301 489-1 Clause 9.8.2 and EN 61000-4-5 for the measurement methods

This test simulates a lightning event by inducing transients onto the AC/DC power supply lines in common mode (Line to Ground) and differential mode (Line to Line). Each device was tested in a total of two surge configurations: Line to Ground (L-G): Combination Wave, Line to Protective Earth with 9uF and 100ohm and Neutral to Protective Earth with 9uF and 100ohm, common mode, generator earthed.

Line to Line (L-L): Combination Wave,

Line to Neutral with 18uF, differential mode, generator floated.

2 ohm : the source impedance of the low-voltage power supply network.

12 ohm : the source impedance of the low-voltage power supply network and ground.

- If not otherwise specified the surges have to be applied synchronized to the voltage phase at the zero-crossing and the peak value of the a.c. voltage wave (positive and negative).
- The surges have to be applied line to line and line to earth. When testing line to earth, the test voltage has to be applied successively between each of the lines and earth, if there is no other specification.
- The test procedure shall also consider the non-linear current-voltage characteristics of the equipment under test. Therefore the test voltage has to be increased by steps up to the test level

specified in the product standard or test plan. All lower levels including the selected test level shall be satisfied.

d. For testing the secondary protection, the output voltage of the generator shall be increased up to the worst-case voltage breakdown level (let-through level) of the primary protection.

e. Testing shall be performed according to a Test Plan, which shall be included in the test report.

f. To find all critical points of the duty cycle of the equipment, a sufficient number of positive and negative test pulses shall be applied.

## 16.4. Test results

### PASS

Temperature : 25°C  
 Humidity : 49%  
 Atmospheric Pressure : 101kpa  
 Test Engineer : LSL  
 Test Date : 2021-12-1

AC mains power ports:

Coupling Line	Voltage (kV)	Waveform (μs)	Polarity	Actual criterion	Required performance criterion	Result (Pass/Fail)
<input checked="" type="checkbox"/> Line to line	1	1.2/50 (8/20)	Pos./ Neg.	A	B	Pass
<input type="checkbox"/> Line to earth	2	1.2/50 (8/20)	Pos./ Neg.	N/A	B	N/A

Analogue/digital data ports:

Port type	Coupling Line	Voltage (kV)	Waveform (μs)	Polarity	Actual criterion	Required performance criterion	Result (Pass/Fail)
<input type="checkbox"/> Unshielded symmetrical (Wired network port)	Lines to ground	1	1.2/50 (8/20)	Pos./ Neg.	N/A	B	N/A
<input checked="" type="checkbox"/> Unshielded symmetrical (Signal Line)	Lines to ground	1	10/700 (5/320)	Pos./ Neg.	A	B	Pass
<input type="checkbox"/> Unshielded symmetrical	Lines to ground	0.5	10/700 (5/320)	Pos./ Neg.	N/A	B	N/A
<input type="checkbox"/> Coaxial or shielded (.....)	Shield to ground	0.5	1.2/50 (8/20)	Pos./ Neg.	N/A	B	N/A



## 17. CONTINUOUS INDUCED RF DISTURBANCES

### 17.1. Test Specification

Test standard	: ETSI EN 301 489-1
Basic standard	: EN 61000-4-6
Performance criterion	: A
Frequency range & Test level	: 0.15M to 80MHz, 3V
Modulation	: AM 80%, 1kHz sine-wave
Frequency Step	: 1% of fundamental

### 17.2. Block Diagram of Test Setup

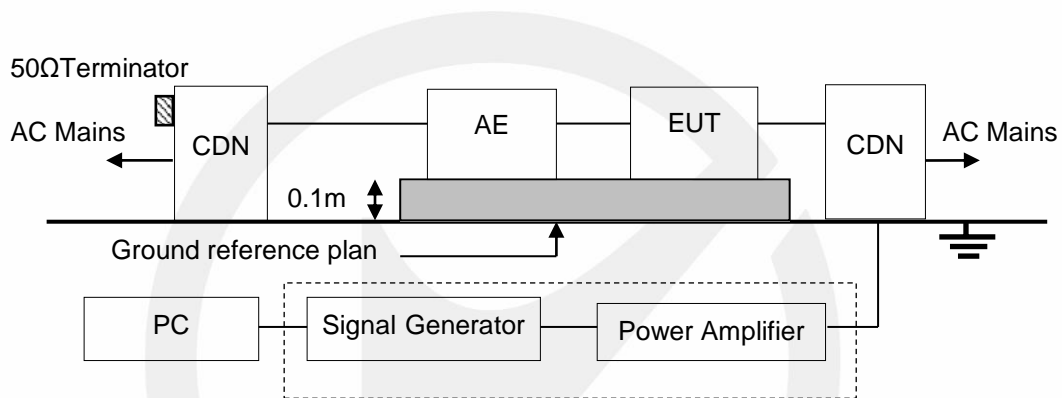

### 17.3. Test Procedure

- Please refer to ETSI EN 301 489-1 Clause 9.5.2 and EN 61000-4-6 for the measurement methods.
- The EUT shall be operated within its intended climatic conditions. The temperature and relative humidity should be recorded.
  - The EUT is placed on a 0.1m high test table, and a well-grounded cable is connected to metallic plane above the test table.
  - All cables/wires must be laid out on test plate (3cm in thickness), and the EUT is set up on test plate (10 cm in thickness) as shown in test setup photo, and the cables/wires must not be in mid-air, they should be touching the surface of test plate. Ensure that the EUT is properly connected to the accessory equipment.
  - The test shall be performed with the test generator connected to each of the coupling and decoupling devices in turn while the other non-excited RF-input ports of the coupling devices are terminated by a 50 ohm load resistor.
  - The frequency range is swept from 150 kHz to 80 MHz, using the signal levels established during the setting process, and with the disturbance signal 80% amplitude modulated with a 1 kHz sine wave, pausing to adjust the RF-signal level or to switch coupling devices as necessary. The rate of sweep shall no exceed  $1.5 \times 10^{-3}$  decades/s. Where the frequency is swept incrementally, the step size shall no exceed 1% of the start and thereafter 1% of the preceding frequency value.
  - The dwell time at each frequency shall not be less than the time necessary for the EUT to be exercised, and able to respond. Sensitive frequencies e.g. clock frequency (ies) and harmonics or frequencies of dominant interest shall be analyzed separately.
  - Attempts should be made to fully exercise the EUT during testing, and to fully interrogate all exercise modes selected for susceptibility
  - Testing shall be performed according to a Test Plan, which shall be included in the test report.

### 17.4. Test results

#### PASS

Temperature : 25°C  
 Humidity : 49%  
 Atmospheric Pressure : 101kpa  
 Test Engineer : LSL  
 Test Date : 2021-12-1

Range (MHz)	Levers (V)	Injection port	Coupling type	Actual criterion	Required performance criterion	Result (Pass/Fail)
0.15-80	3	<input checked="" type="checkbox"/> AC mains power ports	<input checked="" type="checkbox"/> CDN <input type="checkbox"/> EM Clamp <input type="checkbox"/> Current Clamp <input type="checkbox"/> Direct injection	A	A	Pass
0.15-80	3	<input type="checkbox"/> DC network power ports	<input type="checkbox"/> CDN <input type="checkbox"/> EM Clamp <input type="checkbox"/> Current Clamp <input type="checkbox"/> Direct injection	N/A	N/A	N/A
0.15-80	3	<input checked="" type="checkbox"/> Analogue/digital data ports (Signal Line)	<input type="checkbox"/> CDN <input checked="" type="checkbox"/> EM Clamp <input type="checkbox"/> Current Clamp <input type="checkbox"/> Direct injection	A	A	Pass
0.15-80	3	<input type="checkbox"/> Analogue/digital data ports (network ports)	<input type="checkbox"/> CDN <input type="checkbox"/> EM Clamp <input type="checkbox"/> Current Clamp <input type="checkbox"/> Direct injection	N/A	N/A	N/A

## 18. RANSIENTS AND SURGES IN THE VEHICULAR ENVIRONMENT

### 18.1. Test Specification

Test standard	: ETSI EN 301 489-1
Basic standard	: ISO 7637-2
Performance criterion	: A & B
Number of pulses	: 10 pulses
duration	: 20 min

### 18.2. Block Diagram of Test Setup

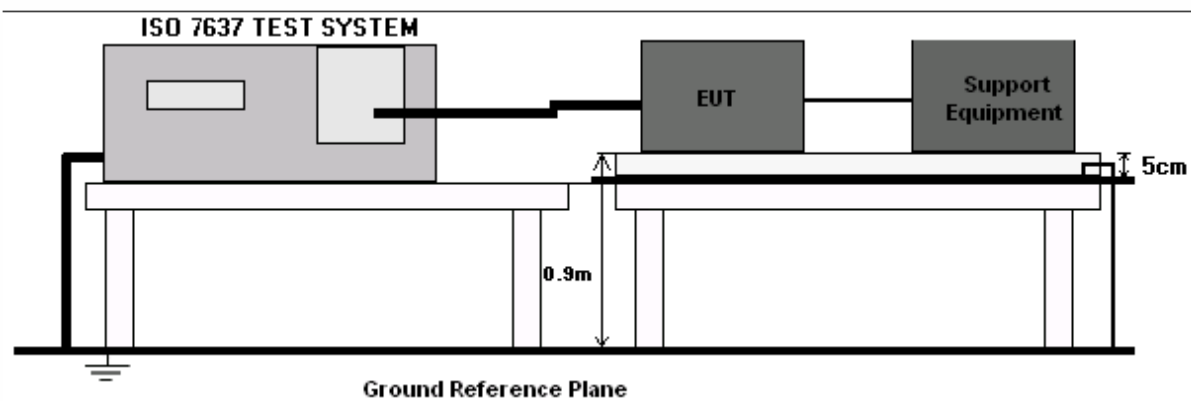

### 18.3. Test Procedure

According to ETSI EN 301 489-1 Clause 9.6 and ISO 7637-2 [8] Severity Levels and Performance Criterion

Test pulse number	Immunity test level	Required functional status
1	III	B
2a	III	B
2b	III	B
3a	III	A
3b	III	A
4	III	B

These tests are applicable to radio and ancillary equipment intended for vehicular use.

These tests shall be performed on nominal 12 V and 24 V DC supply voltage input ports of mobile radio and ancillary equipment, which are also intended for mobile use in vehicles.

These tests shall be performed on a representative configuration of the mobile radio equipment, the associated ancillary equipment, or a representative configuration of the combination of radio and ancillary equipment.

These tests assess the ability of the EUT to operate as intended in the event of transients and surges present on their DC power input ports in a vehicular environment

The test method shall be in accordance with ISO 7637-2 [8], clause 4 for 12 V DC and 24 V DC powered equipment.

The test method shall be in accordance with ISO 7637-2 [8], clause 4, applying pulses 1, 2a, 2b, 3a, 3b, and 4, using immunity test level III. For the purpose of EMC testing it is sufficient to apply pulses 1, 2a, 2b and 4, 10 times each, and apply the test pulses 3a and 3b for 20 minutes each.

#### 18.4. Test Results

**Not applicable.**



## 19. VOLTAGE DIPS AND INTERRUPTIONS

### 19.1. Test Specification

Test standard	: ETSI EN 301 489-1
Basic standard	: EN 61000-4-11
Test level	: <input checked="" type="checkbox"/> 0%, 0.5 period, Criterion B
	<input checked="" type="checkbox"/> 0%, 1 periods for 50Hz, Criterion C
	<input checked="" type="checkbox"/> 70%, 25 periods for 50Hz, Criterion C
	<input checked="" type="checkbox"/> 0%, 250 periods for 50Hz, Criterion C

### 19.2. Block Diagram of Test Setup

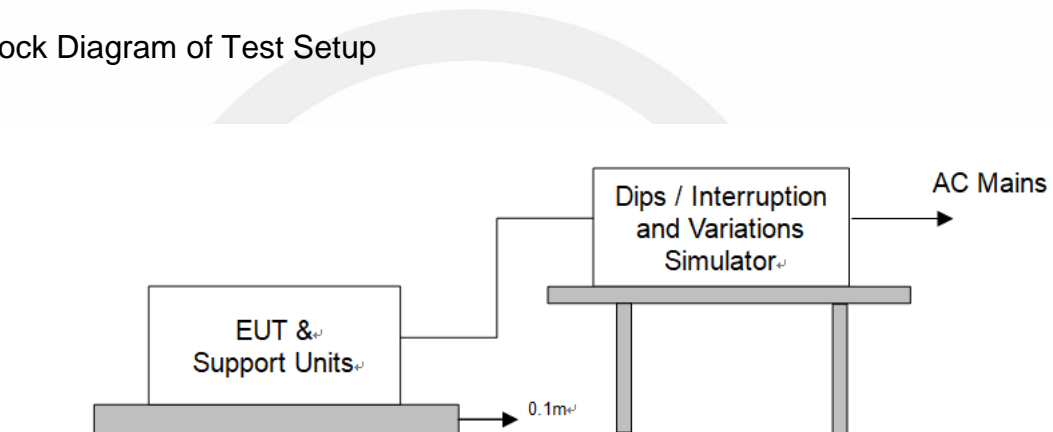

### 19.3. Test Procedure

- Please refer to ETSI EN 301 489-1 Clause 9.7.2 and EN 61000-4-11 for the measurement methods.
- Where the equipment has a rated voltage the following shall apply - If the voltage range does not exceed 20% of the lower voltage specified for the rated voltage range, a single voltage within that range may be specified as a basis for test level specification.
    - In all other cases, the test procedure shall be applied for both the lowest and highest voltages declared in the voltage range.
  - Test Conditions
    - Select operated voltage and frequency of EUT - Test of interval: 10 sec.
    - Level and duration: Sequence of 3 dips/interrupts.
    - Voltage rise (and fall) time: 1.5  $\mu$ s.

## 19.4. Test results

**PASS**

Temperature : 25°C  
 Humidity : 49%  
 Atmospheric Pressure : 101kpa  
 Test Engineer : LSL  
 Test Date : 2021-12-1

	Test Level (% UT)	Phase angle (°)	Input Voltage (V)	Freq (Hz)	Duration (periods)	Actual criterion	Required performance criterion	Result (Pass /Fail)
<input checked="" type="checkbox"/> Voltage dips	0%	0°, 180°	AC 230V	50	0.5	A	B	Pass
<input checked="" type="checkbox"/> Voltage dips	0%	0°, 180°	AC 230V	50	1	A	C	Pass
<input checked="" type="checkbox"/> Voltage dips	70%	0°, 180°	AC 230V	50	25	B	C	Pass
<input checked="" type="checkbox"/> Voltage interruptions	0%	0°, 180°	AC 230V	50	250	C	C	Pass

**Note:** C: During the test, the EUT shut down, after the test, it can be reset by user.

## 20. PHOTOGRAPHS

### 20.1. Photos of Conducted Emissions from the AC Mains Power Ports



### 20.2. Asymmetric mode conducted emissions Wired network ports



### 20.3.Photos of Radiation Emission Measurement

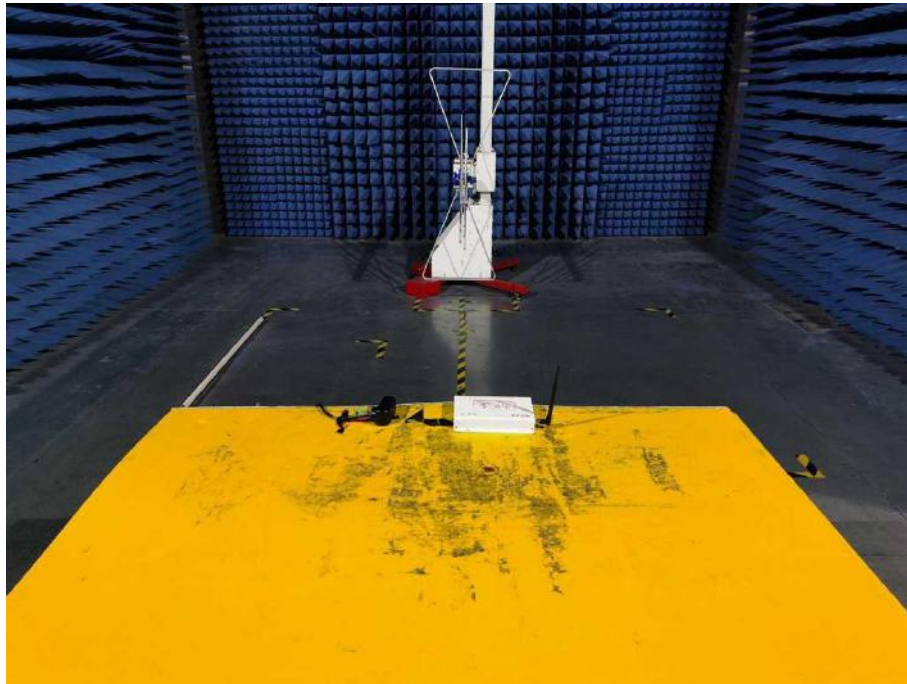

### 20.4.Photo of Harmonic / Flicker Measurement

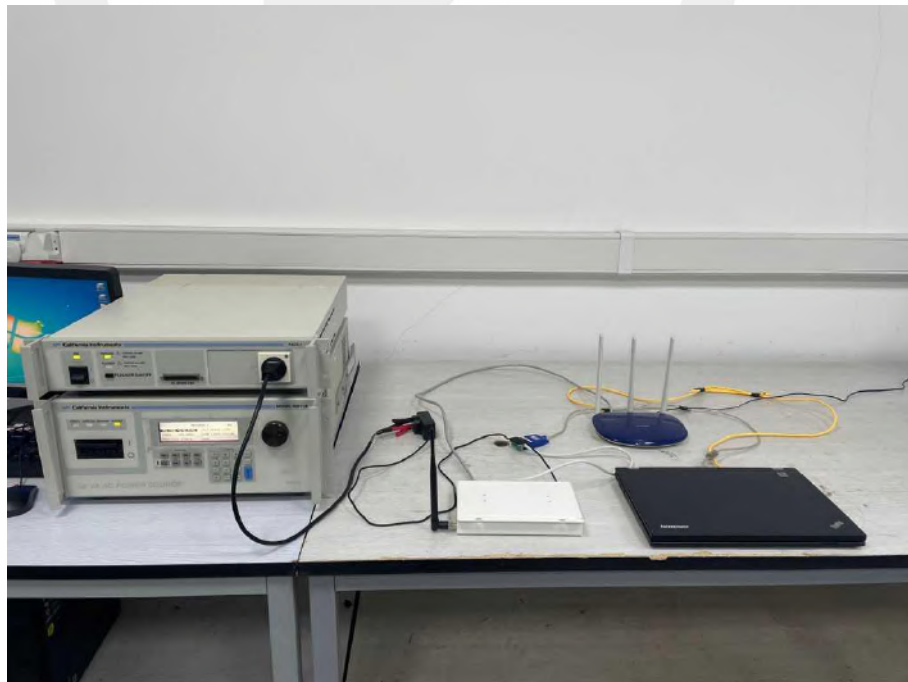



### 20.5. Photo of Electrostatic Discharges

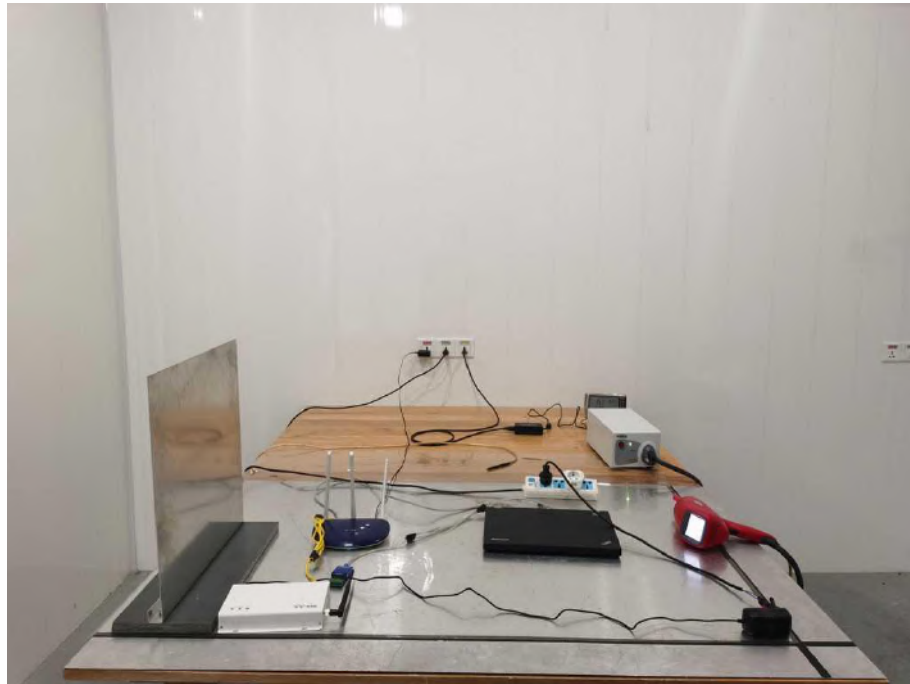

### 20.6. Photo of Continuous RF Electromagnetic Field Disturbances

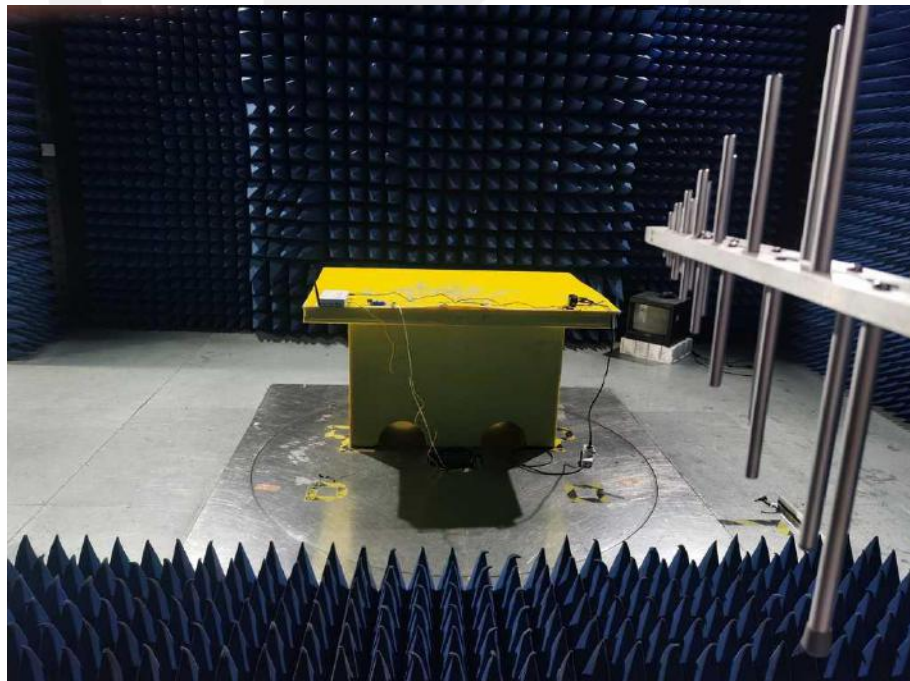

### 20.7.Photos of Electrical Fast Transients/Burst(AC Main)

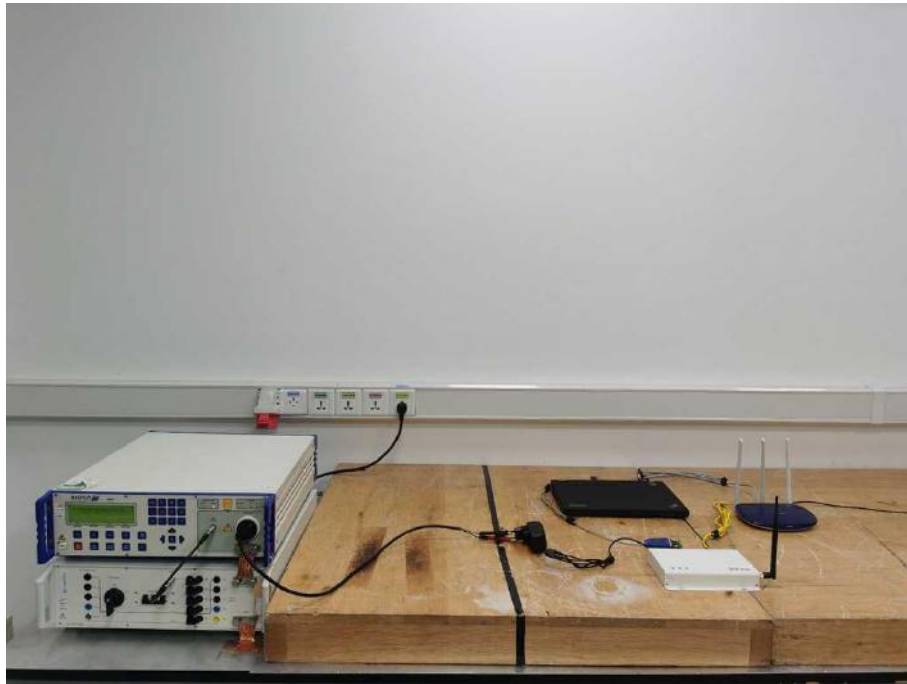

### 20.8.Photos of Electrical Fast Transients/Burst (Wired network ports)

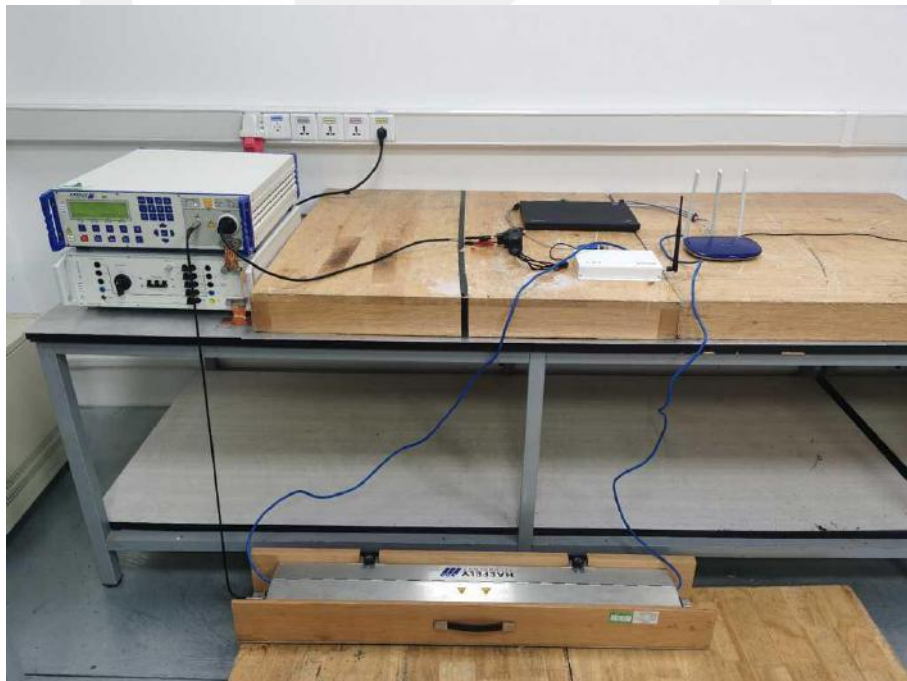

### 20.9.Photos of Surges(AC Main)

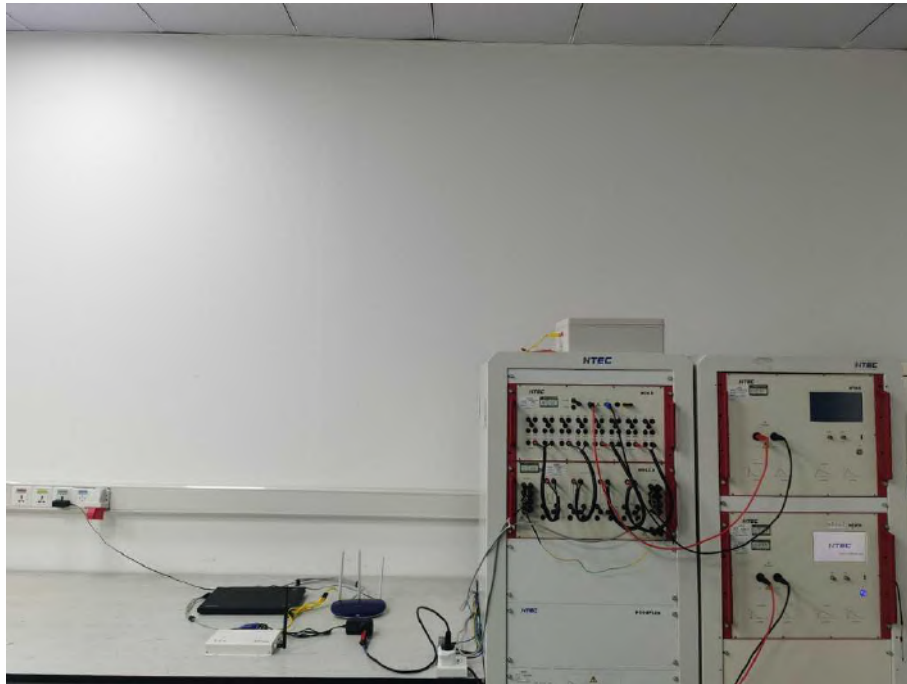

### 20.10.Photos of Surges (Wired network ports)



20.11.Photos of Continuous Induced RF Disturbances(AC Main)

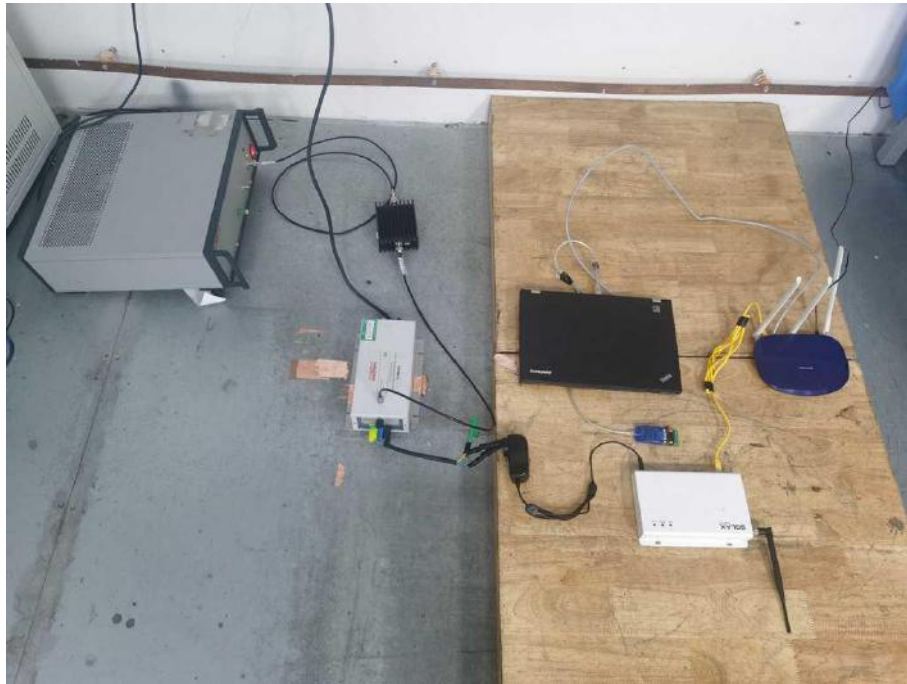

20.12.Photos of Continuous Induced RF Disturbances(Wired network ports)

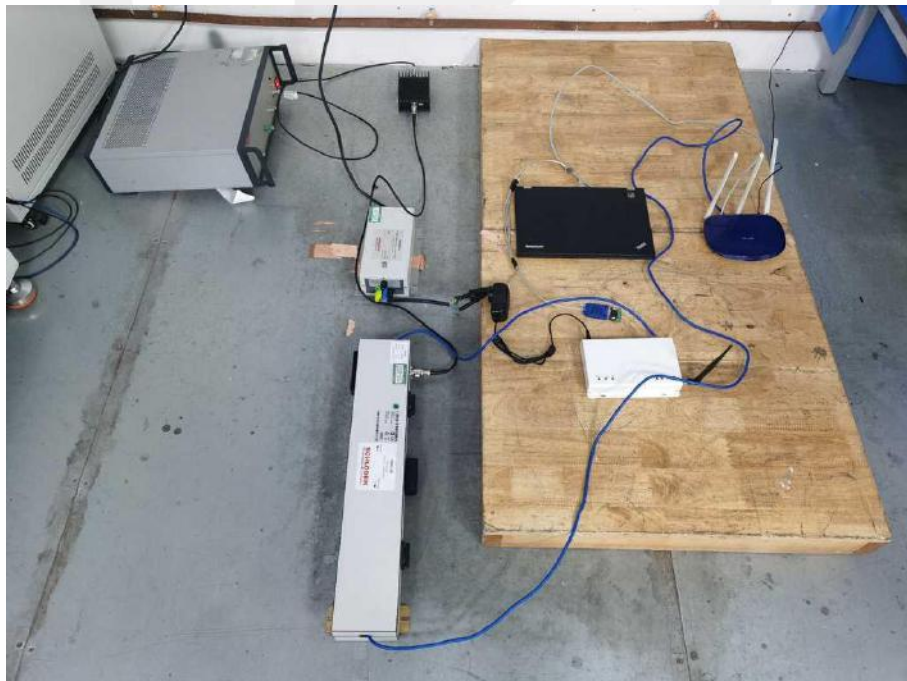

### 20.13. Photo of Voltage Dips and Interruptions

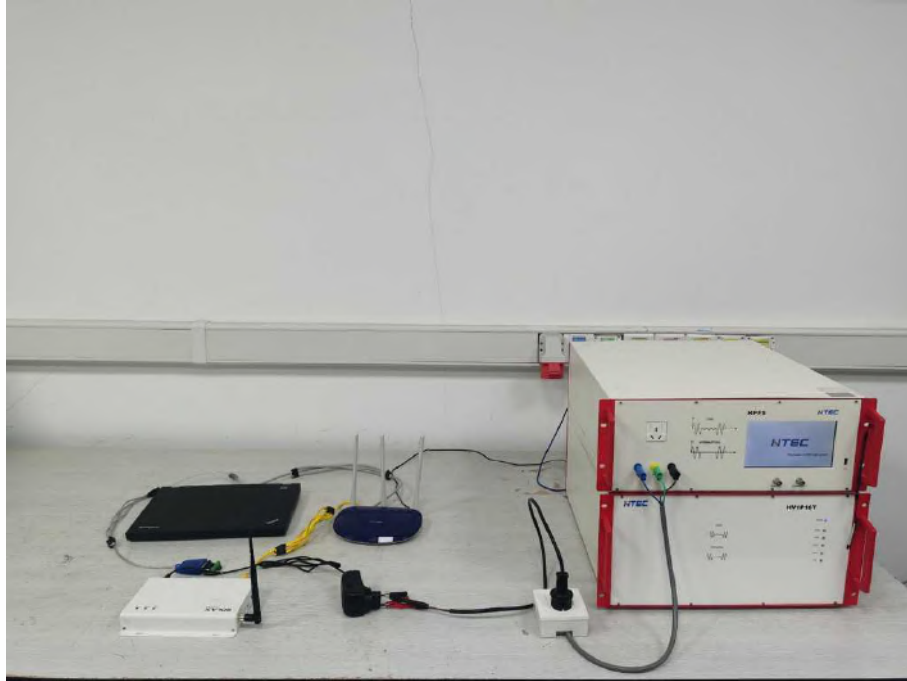

## 21. PHOTOS OF EUT

### EUT View 1

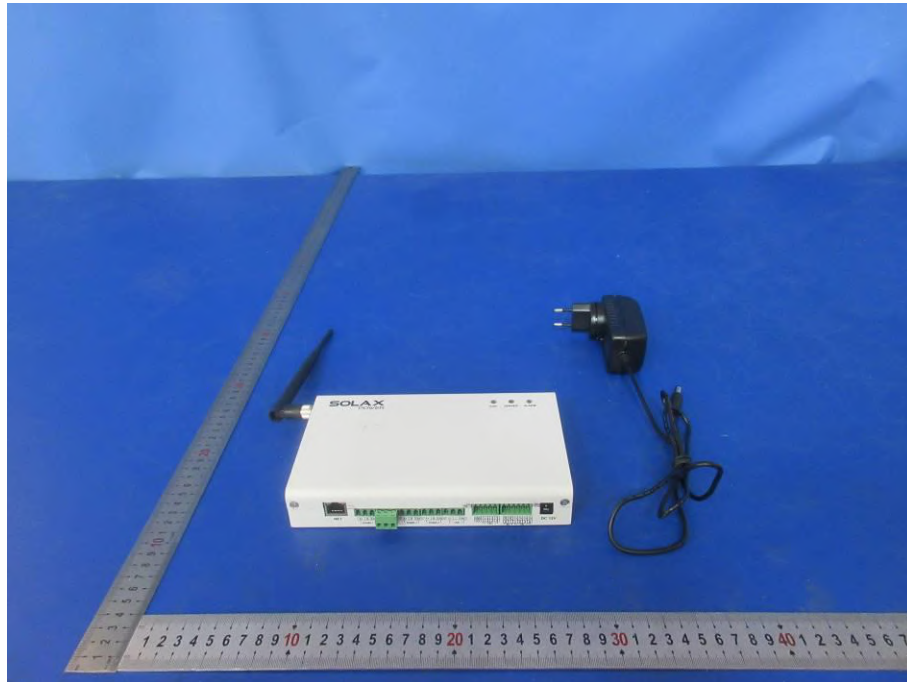

### EUT View 2



**EUT View 3**



**EUT View 4**



**EUT View 5**

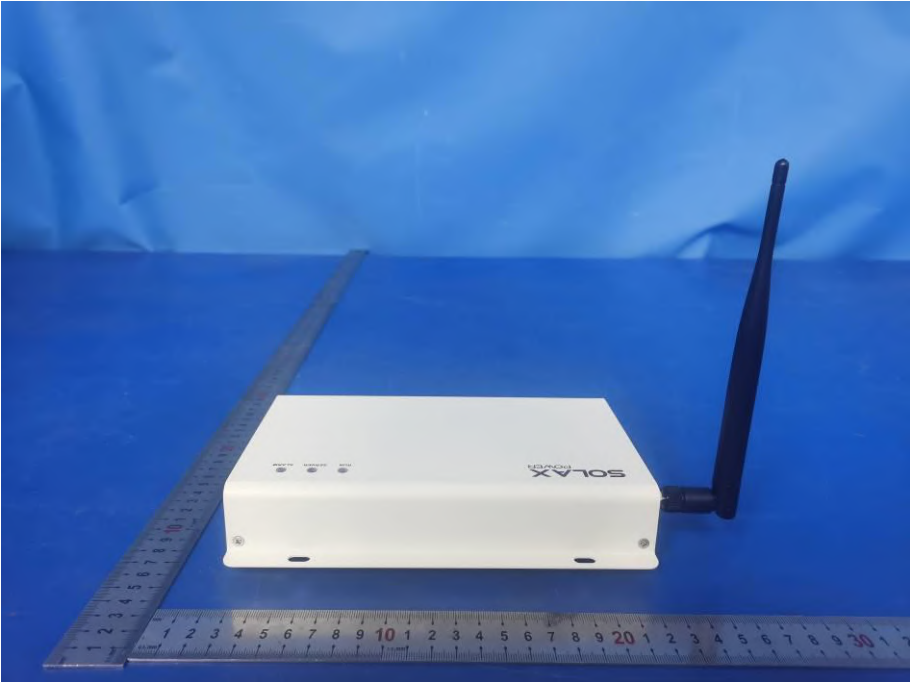

**EUT View 6**





**EUT View 7**

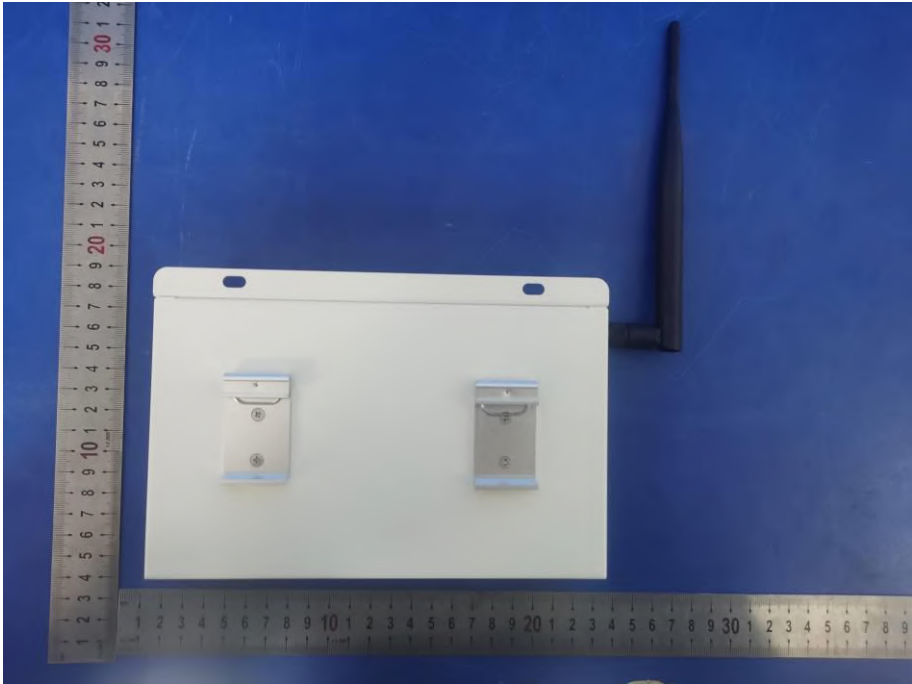

**EUT View 8**



**EUT Housing and Board View 1**



**Solder Board-Component View 1**

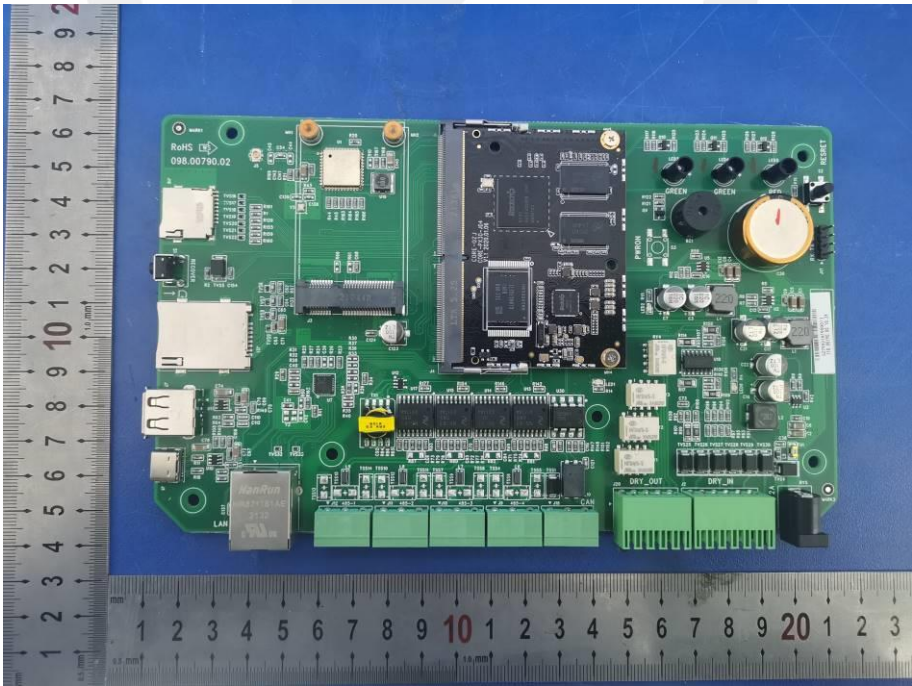

**Solder Board-Component View 2**

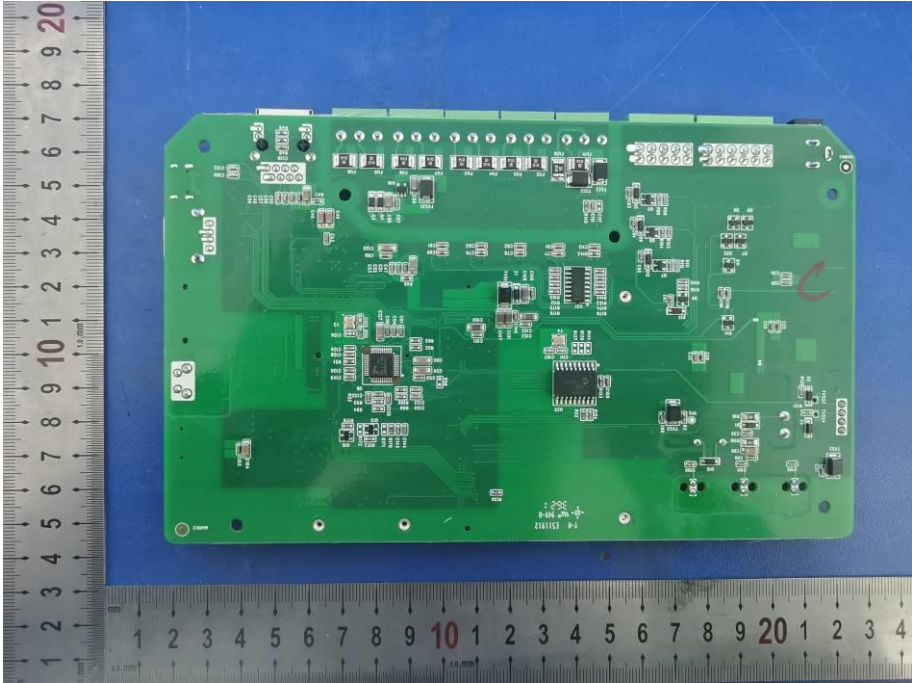

**Solder Board-Component View 3**

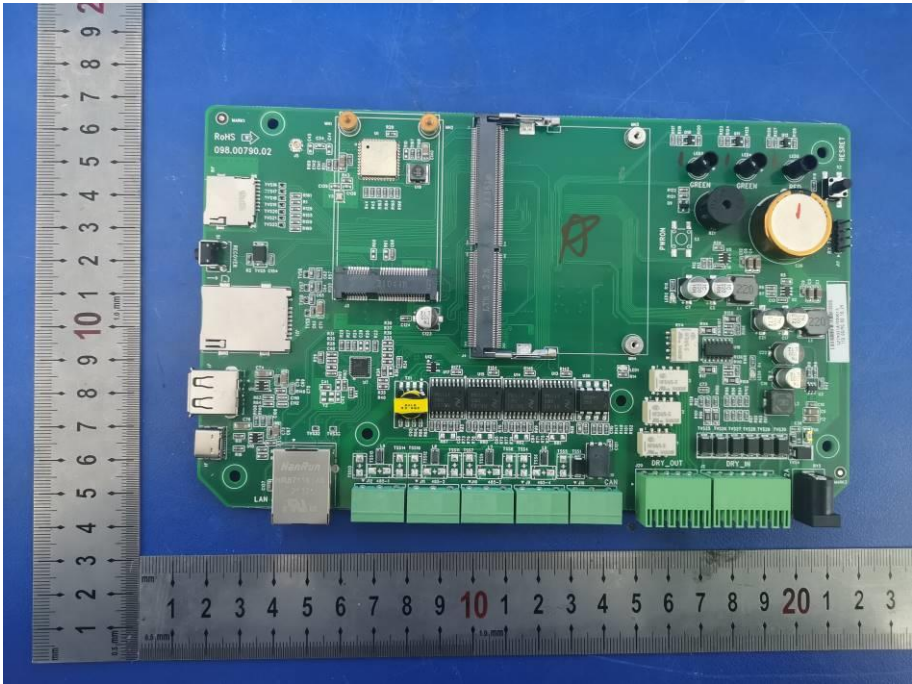

**Solder Board-Component View 4**

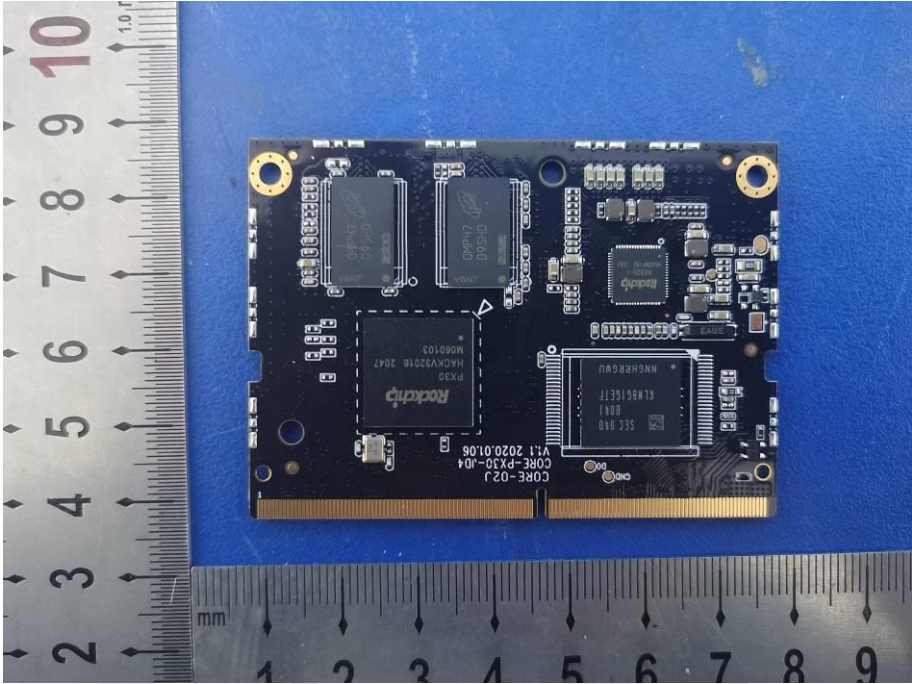

**Solder Board-Component View 5**

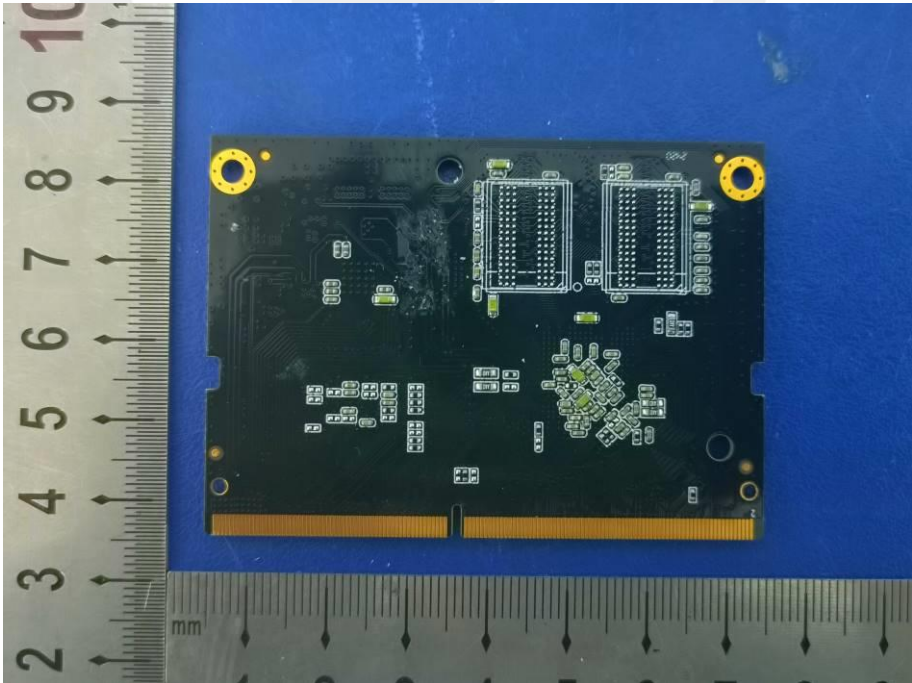

**Solder Board-Component View 6**

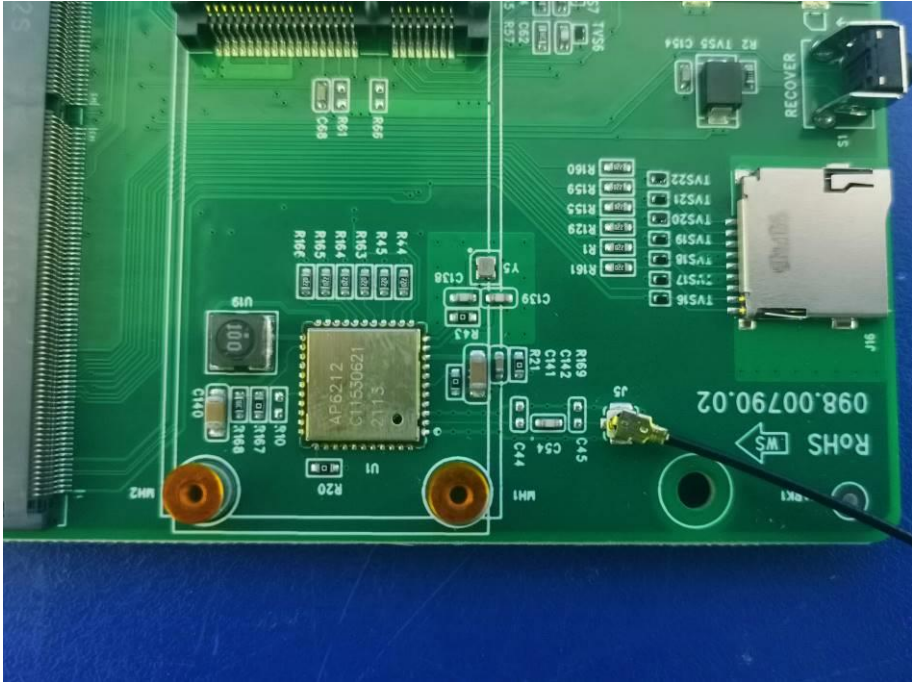

**Antenna**

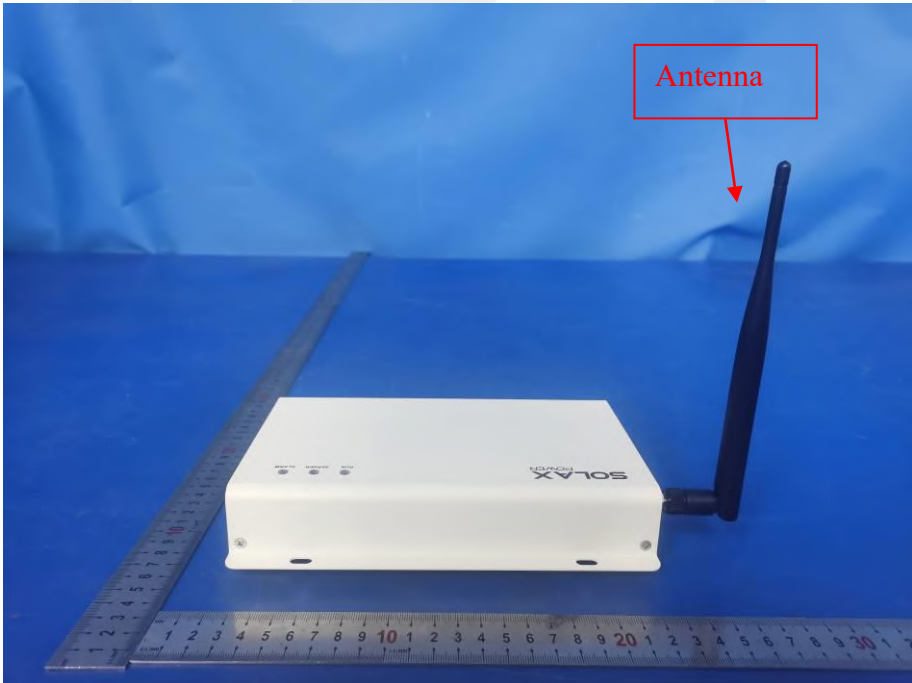

\*\*\* End of Report \*\*\*

# 声明 Statement

1. 本报告无授权批准人签字及“检验报告专用章”无效；  
This report will be void without authorized signature or special seal for testing report.
2. 未经许可本报告不得部分复制；  
This report shall not be copied partly without authorization.
3. 本报告的检测结果仅对送测样品有效，委托方对样品的代表性和资料的真实性负责；  
The test results or observations are applicable only to tested sample. Client shall be responsible for representativeness of the sample and authenticity of the material.
4. 本检测报告中检测项目标注有特殊符号则该项目不在资质认定范围内，仅作为客户委托、科研、教学或内部质量控制等目的使用；  
The observations or tests with special mark fall outside the scope of accreditation, and are only used for purpose of commission, research, training, internal quality control etc.
5. 本检测报告以实测值进行符合性判定，未考虑不确定度所带来的风险，本实验室不承担相关责任，特别约定、标准或规范中有明确规定的除外；  
The test results or observations are provided in accordance with measured value, without taking risks caused by uncertainty into account. Without explicit stipulation in special agreements, standards or regulations, EMTEK shall not assume any responsibility.
6. 对本检测报告若有异议，请于收到报告之日起 20 日内提出；  
Objections shall be raised within 20 days from the date receiving the report.